

4 MINIATURE ALUMINUM ELECTROLYTIC CAPACITORS

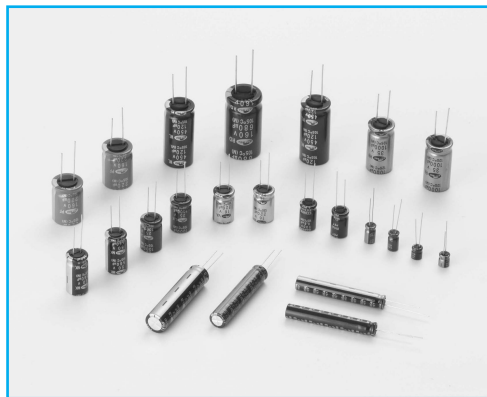

PACKING

● BULK PACKING QUANTITY(pcs) / BOX

SIZE		BULK (QUANTITY)		
∅D	L (mm)	V-Bag	INNER BOX	MIDDLE BOX
4	5, 7	500	10000	40000
5	5, 7, 11	500	7000	28000
6.3	5, 7, 11	500	6000	24000
8	5, 7	500	5000	20000
	11.5	300	3600	14400
10	12.5	200	2400	9600
	16	200	2000	8000
	20, 25	200	1600	6400
	30	100	1200	4800
12.5	16	100	1200	4800
	20	100	1000	4000
	25	100	900	3600
	30	100	800	3200
16	16	-	800	3200
	20	-	600	2400
	25	-	500	2000
	31.5, 35.5, 40	-	400	1600
	45, 50	-	250	1000
18	16	-	600	2400
	20	-	500	2000
	25, 31.5	-	400	1600
	35.5, 40	-	300	1200
	45, 50	-	250	1000

● CUTTING PACKING QUANTITY(pcs) / BOX

SIZE		CUTTING (QUANTITY)		
∅D	L (mm)	V-Bag	INNER BOX	MIDDLE BOX
4	5, 7	500	9000	36000
5	5, 7, 11	500	7000	28000
6.3	5, 7, 11	500	6000	24000
8	5, 7	500	5000	20000
	11.5	300	3600	14400
10	12.5	-	800	12800
	16	-	600	9600
	20	-	500	8000
	25	-	400	6400
	30	-	350	5600
12.5	16	-	400	6400
	20	-	300	4800
	25	-	250	4000
16	16, 20, 25	-	400	1200
	31.5, 35.5	-	400	1200
	40 ↑	-	400	1200
	16, 20, 25	-	300	900
18	31.5, 35.5	-	300	900
	40 ↑	-	300	900
	20	41	-	240
22	35.5 ↓	-	200	600
	40 ↑	-	200	600

TAPING

● Ammo

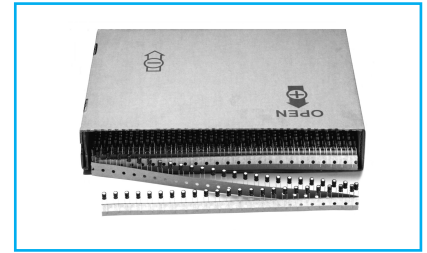

● Lead Taping Capacitors for Automatic Insertion

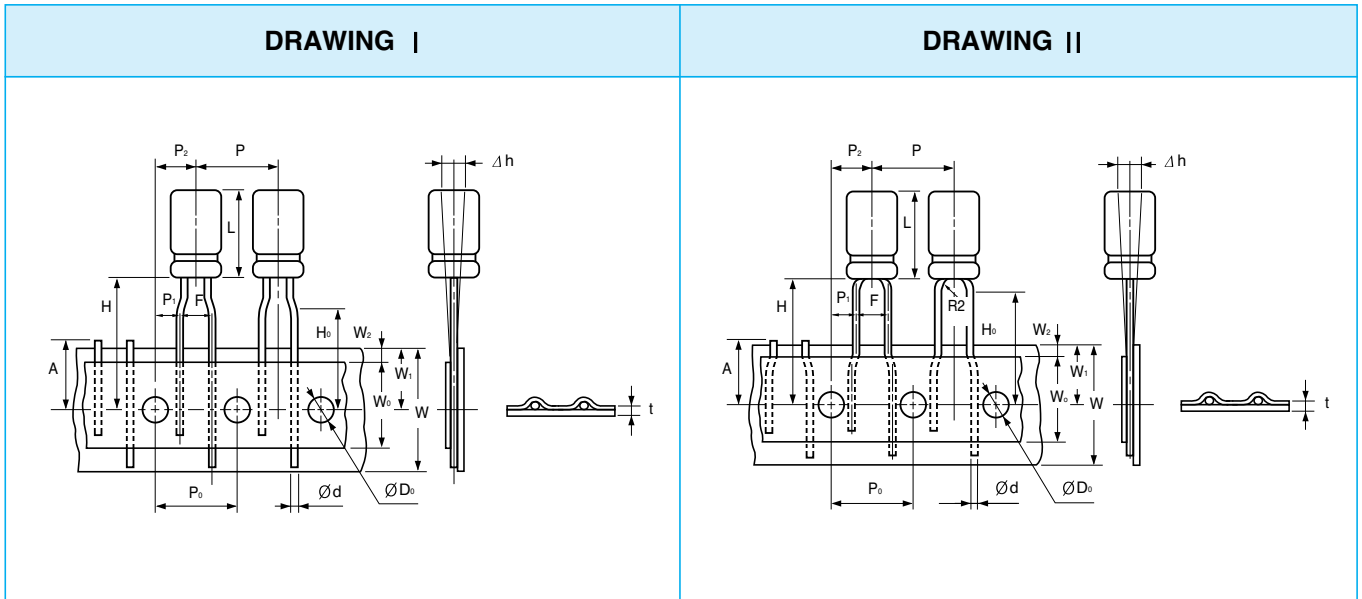

● DIMENSIONS

Unit : mm

Applicable Drawing No.			II			III		I							
Description	Symbol	Tolerance	Ø4	Ø5		Ø6.3	Ø8	Ø4	Ø5		Ø6.3		Ø8		
Case Height	L	*Note	5, 7	5	7~11	5	7~11	5	5, 7	5	7~11	5	7~11	5	9, 11.5
Lead Dia.	Ød	±0.05	0.45	0.45	0.5	0.45	0.5	0.45	0.45	0.45	0.5	0.45	0.5	0.45	0.6
Body Pitch	P	±1.0	12.7		12.7	12.7	12.7		12.7		12.7		12.7	12.7	
Feeding Hole Pitch	P0	±0.2	12.7		12.7	12.7	12.7		12.7		12.7		12.7	12.7	
Feeding Hole Alignment	P1	±0.7	5.1		5.1	5.1	3.85		3.85		3.85		3.85	3.85	
Feeding Hole Alignment	P2	±1.0	6.35		6.35	6.35	6.35		6.35		6.35		6.35	6.35	
Lead Center Spacing	F	+0.6 -0.2	2.5		2.5	2.5	5.0		5.0		5.0		5.0	5.0	
Body Inclination	Δh	±2.0	0		0	0	0		0		0		0	0	
Tape Width	W	±0.5	18.0		18.0	18.0	18.0		18.0		18.0		18.0	18.0	
Adhesive Tape Width	W0	min.	9.5		9.5	9.5	9.5		9.5		9.5		9.5	12.5	
Feeding Hole Alignment	W1	±0.5	9.0		9.0	9.0	9.0		9.0		9.0		9.0	9.0	
Adhesive Tape Margin	W2	max.	2.0		2.0	2.0	2.0		2.0		2.0		2.0	2.0	
Length from Seating Plane	H	±0.5	18.0		17.5	18.5	18.5 (5, 7mmL = 17.5)		17.5		20.0		17.5	20.0	
Lead Clinch Height	H0	±0.5	17.0		—	—	16.5		16.5		16.5		16.5	16.5	
Feeding Hole Dia.	ØD0	±0.2	4.0		4.0	4.0	4.0		4.0		4.0		4.0	4.0	
Total Tape Thickness	t	±0.2	0.6		0.6	0.6	0.6		0.6		0.6		0.6	0.6	
Cut Lead Height	A	max.	11.0		11.0	11.0	11.0		11.0		11.0		11.0	11.0	
Taping Code	Ammo	⊕ leader	PC		PC	PE	PA		PA		PA		PA	PG	

* Note : Refer to the drawing of each series for tolerance.

MINIATURE TYPES

TAPING

● Lead Taping Capacitors for Automatic Insertion

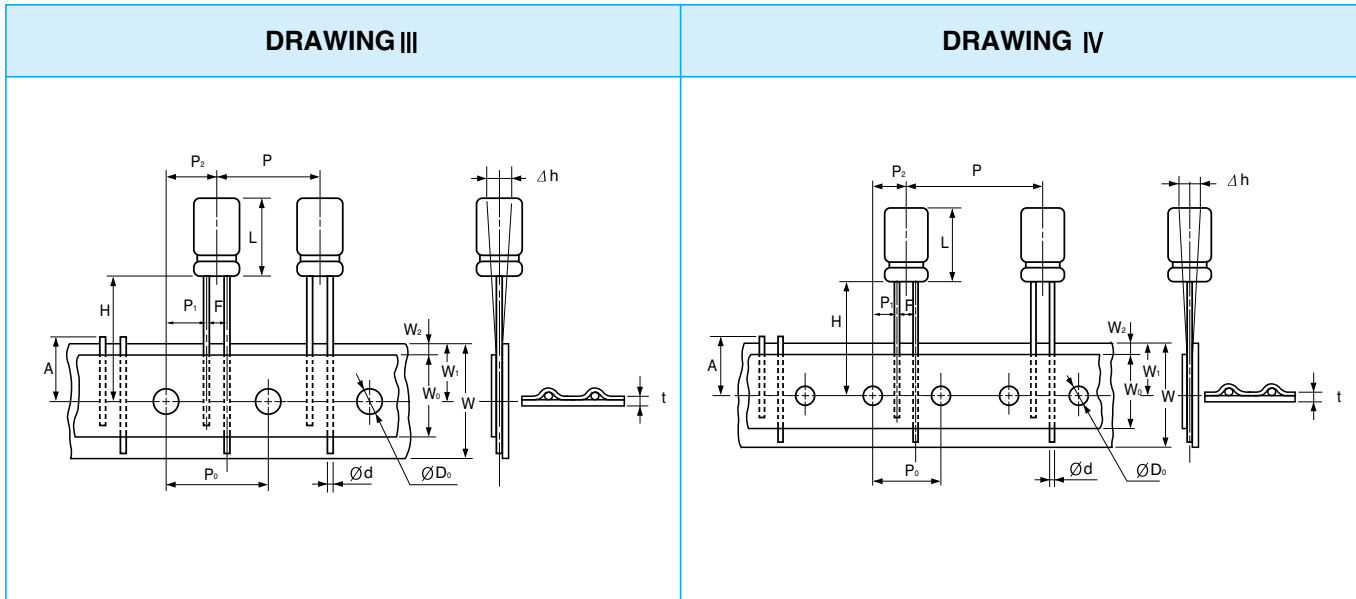

● DIMENSIONS

Unit : mm

Applicable Drawing No.			III	III	IV	IV	IV
Description	Symbol	Tolerance	Ø10	Ø12.5	Ø16	Ø18	Ø18
Case Height	L	max.	27.0	27.0	37.5	37.5	
Lead Dia.	Ød	±0.05	0.6	0.6	0.8	0.8	
Body Pitch	P	±1.0	12.7	15.0	25.4	30.0	30.0
Feeding Hole Pitch	P ₀	±0.2	12.7	15.0	12.7	15.0	15.0
Feeding Hole Alignment	P ₁	±0.7	3.85	5.0	3.85	3.75	3.75
Feeding Hole Alignment	P ₂	±1.0	6.35	7.5	6.35	7.5	7.5
Lead Center Spacing	F	^{+0.6} -0.2	5.0	5.0	7.5	7.5	
Body Inclination	Δh	±2.0	0	0	0	0	
Tape Width	W	±0.5	18.0	18.0	18.0	18.0	
Adhesive Tape Width	W ₀	min.	12.5	12.5	12.5	12.5	
Feeding Hole Alignment	W ₁	±0.5	9.0	9.0	9.0	9.0	
Adhesive Tape Margin	W ₂	max.	2.0	2.0	2.0	2.0	
Length from Seating Plane	H	±0.5	18.5	18.5	18.5	18.5	
Feeding Hole Dia.	ØD ₀	±0.2	4.0	4.0	4.0	4.0	
Total Tape Thickness	t	±0.2	0.6	0.7	0.7	0.7	
Cut Lead Height	A	max.	11.0	11.0	11.0	11.0	
Taping Code	Ammo	⊕ leader	PA	PH	PL	PA	PA

● PACKAGING Q'ty(pcs.)/Box

Unit : mm

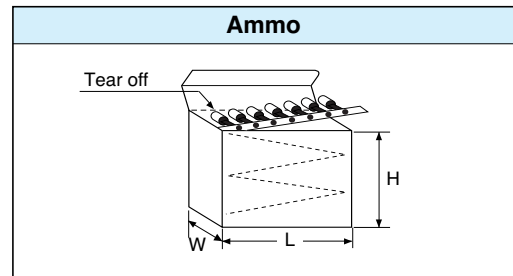

Size		Ammo			
ØD	Case Height	L	H	W	Q'ty
4	5, 7	332	230	42	2500
	11				
5	5, 7	332	230	49	2000
	11				
6.3	5, 7	332	230	42	1500
	11				
8	5, 7	332	230	42	1000
	11.5				
10	12.5, 16	332	190	51	500
	20, 25				
12.5	16, 20, 25	342	240	62	400
16	16, 20, 25	342	240	62	250
	31.5, 35.5				
18	16, 20, 25	342	240	62	200
	31.5, 35.5				

MINIATURE ALUMINUM ELECTROLYTIC CAPACITORS



SD Standard, For General Purposes Series

- Standard series for general purposes
- High voltage, high capacitance series
- Voltage range of 6.3~500V
- Complied to the RoHS directive

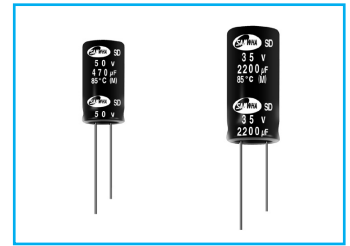

Item	Characteristics										
Operating temperature range	WV	6.3 ~ 450									
	Temperature range	-40 ~ +85°C									
Leakage current max.	WV ≤ 100	I = 0.01CV or 3μA whichever is greater (after 2 min) I = 0.03CV or 4μA whichever is greater (after 1 min)									
	WV > 100	I = 0.02CV + 15μA (after 5 min)									
Capacitance tolerance	±20% at 120Hz, 20°C										
Dissipation factor max. (at 120Hz, 20°C)	Capacitance > 1000μF : tanδ increases by 0.02 for each 1000μF from below value.										
	WV	6.3	10	16	25	35	50	63	100	160 ~ 250	350 ~ 500
tanδ	0.28	0.24	0.20	0.16	0.14	0.12	0.10	0.08	0.15	0.20	
Low temperature characteristics (Impedance ratio at 120Hz)	WV	6.3	10	16	25	35	50~100	160	200~350	400~450	500
	Z-25°C/Z+20°C	5	4	3	2	2	2	4	6	10	12
	Z-40°C/Z+20°C	12	10	8	5	4	3	6	8	12	-
Load life (after application of the rated voltage for 2000 hours at 85°C)	Leakage current	Less than specified value									
	Capacitance change	Within ±20% of initial value									
	tanδ	Less than 200% of specified value									
Shelf life (at 85°C)	After 1000 hours no load test, leakage current, capacitance and tanδ are same as load life value. The measurement shall be performed at 20°C by the KS C IEC 60384 - 4										

DRAWING

Unit : mm

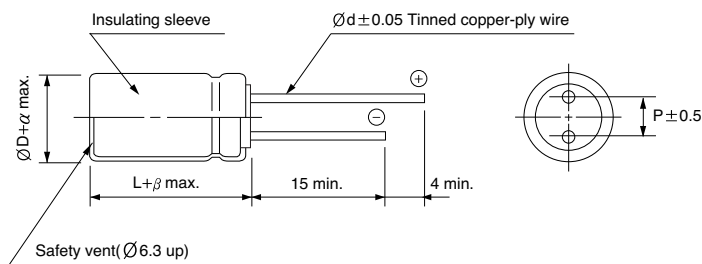

ØD	5	6.3	8	10	12.5	16	18	22	
P	2.0	2.5	3.5	5.0	5.0	7.5	7.5	10.0	
Ød	0.5	0.5	0.6	0.6	0.6	0.8	0.8	1.0	
α								0.5	1.0
β	1.5		2.0				3.0		

FREQUENCY COEFFICIENT OF PERMISSIBLE RIPPLE CURRENT

WV	μF	Frequency	60Hz	120Hz	1kHz	10kHz	50kHz	100kHz ≤
		~ 47	0.75	1.00	1.55	2.00	2.00	2.00
6.3~100	68 ~ 680	0.80	1.00	1.35	1.50	1.62	1.75	
	1000 ~	0.85	1.00	1.15	1.15	1.32	1.50	
160~500	~ 220	0.80	1.00	1.40	1.60	1.70	1.80	
	330 ~	0.90	1.00	1.13	1.15	1.32	1.50	

MINIATURE ALUMINUM ELECTROLYTIC CAPACITORS

SD series

● DIMENSIONS & MAXIMUM PERMISSIBLE RIPPLE CURRENT

WV μF	6.3	10	16	25	35	50	63	100	160	200	250	350	400	450	500
	1.0						5×11 21	5×11 23	5×11 23						
1.5						5×11 26	5×11 28	5×11 28						8×11.5 32	
2.2						5×11 32	5×11 34	5×11 34						8×11.5 33	
3.3						5×11 39	5×11 42	5×11 42	6.3×11 45	6.3×11 45	6.3×11 48	8×11.5 53	8×11.5 56	8×11.5 50	
4.7						5×11 46	5×11 50	5×11 50	6.3×11 53	6.3×11 57	6.3×11 57	8×11.5 66	10×12.5 73	10×12.5 72	10×16 69
6.8						5×11 56	5×11 60	5×11 60	8×11.5 76	8×11.5 76	8×11.5 76	10×12.5 88	10×12.5 87	10×16 86	10×16 76
10						5×11 68	5×11 72	5×11 76	8×11.5 96	8×11.5 96	10×12.5 107	10×12.5 107	10×16 115	10×20 115	12.5×25 178
15						5×11 83	5×11 89	6.3×11 89	10×12.5 131	10×16 143	10×16 143	10×20 156	12.5×20 165	12.5×20 164	
22						5×11 101	5×11 108	6.3×11 124	10×12.5 156	10×16 173	10×16 170	12.5×20 222	12.5×20 218	12.5×25 217	16×25 265
33						5×11 123	6.3×11 151	8×11.5 178	10×16 209	10×20 232	10×20 247	16×20 297	12.5×25 296	16×25 294	16×31.5 310
47					5×11 131	*6.3×11 169	6.3×11 181	8×11.5 222	10×20 293	10×20 293	12.5×20 319	16×20 353	16×25 387	16×31.5 384	18×31.5 412
68				5×11 144	*6.3×11 182	6.3×11 203	8×11.5 256	10×12.5 293	12.5×20 391	12.5×25 426	16×20 425	16×25 465	16×31.5 488	16×35.5 503	18×35.5 457
100			5×11 162	* 5×11 181	6.3×11 220	8×11.5 291	8×11.5 311	10×16 388	12.5×25 516	16×25 516	16×25 564	18×31.5 592	18×35.5 667	18×40 546	
150			* 5×11 198	6.3×11 246	8×11.5 318	10×12.5 414	10×12.5 422	10×20 528	16×20 632	16×25 691	16×31.5 726	18×40 845	18×40 863	22×45 1283	
220	5×11 201	* 5×11 218	6.3×11 276	6.3×11 327	8×11.5 386	10×12.5 501	10×16 586	12.5×20 737	16×25 873	18×31.5 962	18×35.5 988	22×41 1112	22×45 1183		
330	*6.3×11 283	6.3×11 307	6.3×11 359	8×11.5 431	10×12.5 549	10×16 672	10×20 784	12.5×25 1002	16×35.5 1152	18×35.5 1206	22×41 1495				
470	6.3×11 338	6.3×11 366	8×11.5 476	10×12.5 550	10×16 740	10×20 875	12.5×20 1098	16×25 1328	18×40 1434	22×41 1495					
680	8×11.5 480	8×11.5 520	8×11.5 600	10×16 754	10×20 947	12.5×20 1235	12.5×25 1440	16×31.5 1643	22×41 1831						
1000	8×11.5 581	10×12.5 659	10×12.5 796	10×16 942	12.5×20 1306	12.5×25 1633	16×25 1937	18×31.5 1965							
2200	10×16 983	10×16 1051	10×20 1331	12.5×20 1542	16×25 2032	16×31.5 2220	18×31.5 2445								
3300	10×20 1286	12.5×20 1545	12.5×20 1686	16×25 2194	16×31.5 2502	18×31.5 2765	18×40 2987								
4700	12.5×20 1736	12.5×25 1903	12.5×25 2129	16×25 2448	16×35.5 2905	18×40 3272									
6800	12.5×25 2129	16×25 2332	16×25 2577	18×31.5 3114	18×40 3408	← Case size ØD×L (mm) ← Ripple current (mA rms) at 85°C, 120Hz									
10000	16×25 2629	16×31.5 2830	16×31.5 3176	18×40 3544											
15000	16×35.5 2959	16×35.5 3284	18×35.5 3656												
22000	18×40 3733	18×40 3843	22×41 4012												

MINIATURE ALUMINUM ELECTROLYTIC CAPACITORS



SS Standard, Height 7mmL Series

- Super miniature series with 7mmL height
- Suited for use in compact audio equipment
- Load life of 2000 hours at 85°C
- Complied to the RoHS directive

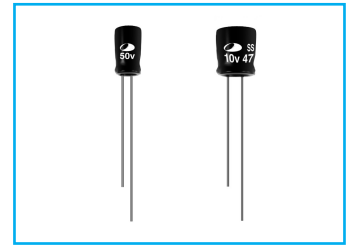
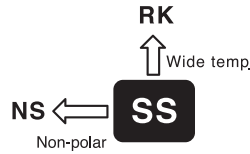
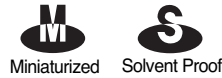

Item	Characteristics								
Operating temperature range	-40 ~ +85°C								
Leakage current max.	$I = 0.01CV$ or $4\mu A$ whichever is greater (after 1 minute)								
Capacitance tolerance	$\pm 20\%$ at 120Hz, 20°C								
Dissipation factor max. (at 120Hz, 20°C)	WV	4	6.3	10	16	25	35, 40	50	63
	$\tan\delta$	0.35	0.24	0.20	0.16	0.14	0.12	0.10	0.10
Low temperature characteristics (Impedance ratio at 120Hz)	WV	4	6.3	10	16, 25	35 ~ 63			
	Z-25°C/Z+20°C	6	4	3	2	2			
	Z-40°C/Z+20°C	12	8	6	4	3			
Load life (after application of the rated voltage for 2000 hours at 85°C)	Leakage current	Less than specified value							
	Capacitance change	Within $\pm 20\%$ of initial value							
	$\tan\delta$	Less than 200% of specified value							
Shelf life (at 85°C)	After 1000 hours no load test, leakage current, capacitance and $\tan\delta$ are same as load life value. The measurement shall be performed at 20°C by the KS C IEC 60384 - 4								

● DRAWING (See page 94)

● DIMENSIONS & MAXIMUM PERMISSIBLE RIPPLE CURRENT

WV	4	6.3	10	16	25	35	40	50	63						
1.0								4 × 7	14	4 × 7	14				
1.5								4 × 7	17	4 × 7	17				
2.2								4 × 7	21	4 × 7	21				
3.3								4 × 7	25	4 × 7	25				
4.7								4 × 7	30	4 × 7	30				
6.8						4 × 7	33	4 × 7	33	4 × 7	37	5 × 7	42		
10					4 × 7	37	4 × 7	40	4 × 7	40	5 × 7	51	5 × 7	51	
15				4 × 7	43	4 × 7	46	5 × 7	57	5 × 7	57	6.3 × 7	72	6.3 × 7	72
22			4 × 7	46	4 × 7	52	5 × 7	64	5 × 7	69	6.3 × 7	80	6.3 × 7	88	
33	4 × 7	43	4 × 7	52	4 × 7	57	5 × 7	73	5 × 7	78	6.3 × 7	98	6.3 × 7	98	
47	4 × 7	51	4 × 7	62	5 × 7	78	5 × 7	87	6.3 × 7	108					
68	5 × 7	71	5 × 7	86	5 × 7	94	6.3 × 7	122							
100	5 × 7	86	5 × 7	104	6.3 × 7	132	6.3 × 7	148							
150	6.3 × 7	122	6.3 × 7	148	6.3 × 7	162									
220	6.3 × 7	148	6.3 × 7	179											

— Ripple current (mA rms) at 85°C, 120Hz
 — Case size $\varnothing D \times L$ (mm)

● FREQUENCY COEFFICIENT OF PERMISSIBLE RIPPLE CURRENT

Frequency	60Hz	120Hz	1kHz	10kHz	50kHz	100kHz ≤
~ 47	0.75	1.00	1.55	2.00	2.00	2.00
68 ~	0.80	1.00	1.35	1.50	1.62	1.75

MINIATURE TYPES

MINIATURE ALUMINUM ELECTROLYTIC CAPACITORS

SE Standard, Height 5mmL Series

- Ultra miniature series with 5mmL height
- Suitable to replace tantalum capacitors at low cost
- Load life of 2000 hours at 85°C
- Complied to the RoHS directive

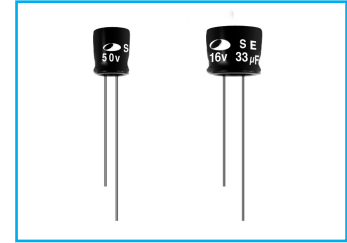
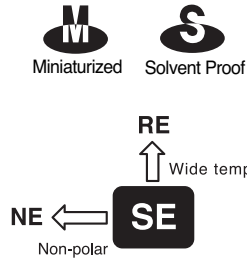

Item	Characteristics									
Operating temperature range	-40 ~ +85°C									
Leakage current max.	I = 0.01CV or 4µA whichever is greater (after 1 minute)									
Capacitance tolerance	±20% at 120Hz, 20°C									
Dissipation factor max. (at 120Hz, 20°C)	WV	4	6.3	10	16	25	35	50	63	
	tanδ	0.35	0.24	0.20	0.16	0.13	0.12	0.09	0.09	
Low temperature characteristics (Impedance ratio at 120Hz)	WV	4	6.3	10	16 ~ 63					
	Z-25°C/Z+20°C	6	4	3	2					
	Z-40°C/Z+20°C	12	8	6	4					
Load life (after application of the rated voltage for 2000 hours at 85°C)	Leakage current	Less than specified value								
	Capacitance change	Within ±20% of initial value								
	tanδ	Less than 200% of specified value								
Shelf life (at 85°C)	After 1000 hours no load test, leakage current, capacitance and tanδ are same as load life value. The measurement shall be performed at 20°C by the KS C IEC 60384 - 4									

● DRAWING (See page 95)

● DIMENSIONS & MAXIMUM PERMISSIBLE RIPPLE CURRENT

µF \ WV	4	6.3	10	16	25	35	50	63
1.0							4×5	13
1.5							4×5	16
2.2						4×5	17	19
3.3					4×5	20	4×5	24
4.7				4×5	21	4×5	23	4×5
6.8			4×5	23	4×5	25	4×5	28
10	4×5	21	4×5	25	4×5	28	4×5	31
15	4×5	26	4×5	31	4×5	34	5×5	44
22	4×5	31	4×5	37	5×5	47	5×5	53
33	4×5	38	5×5	53	5×5	58	6.3×5	76
47	4×5	45	5×5	63	6.3×5	81	6.3×5	91
68	5×5	63	6.3×5	89	6.3×5	98	6.3×5	109
100	5×5	89	6.3×5	108	8×5	140	8×5	157
150	6.3×5	109	8×5	157	8×5	172	8×5	192
220	6.3×5	133	8×5	190	8×5	208		
330	8×5	192						

↑ ↑
Ripple current (mA rms) at 85°C, 120Hz
— Case size ØD×L (mm)

● FREQUENCY COEFFICIENT OF PERMISSIBLE RIPPLE CURRENT

µF \ Frequency	60Hz	120Hz	1kHz	10kHz	50kHz	100kHz ≤
~ 47	0.75	1.00	1.55	2.00	2.00	2.00
68 ~	0.80	1.00	1.35	1.50	1.62	1.75

RD Wide Temperature Range Series

- Standard series for general purpose
- High CV value
- Wide operating temperature range of -55 ~ +105°C
- Complied to the RoHS directive

S
Solvent Proof
WV ≤ 100V

SD → **RD**
Wide temp.

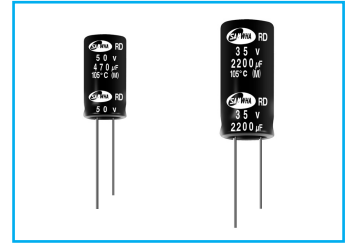

Item	Characteristics										
Operating temperature range	WV	6.3 ~ 100				160 ~ 450				500	
	Temperature range	-55 ~ +105°C				-40 ~ +105°C				-25 ~ +105°C	
Leakage current max.	WV ≤ 100						WV > 100				
	I = 0.01CV or 3µA whichever is greater (after 2 min) I = 0.03CV or 4µA whichever is greater (after 1 min)						I = 0.02CV + 15µA (after 5 min)				
Capacitance tolerance	±20% at 120Hz, 20°C										
Dissipation factor max. (at 120Hz, 20°C)	Capacitance > 1000µF : tanδ increases by 0.02 for each 1000µF from below value.										
	WV	6.3	10	16	25	35	50	63	100	160~250	350~500
tanδ	0.28	0.24	0.20	0.16	0.14	0.12	0.10	0.08	0.15	0.20	
Low temperature characteristics (Impedance ratio at 120Hz)	WV	6.3	10	16	25	35	50~100	160	200~350	400~450	500
	Z-25°C/Z+20°C	5	4	3	2	2	2	4	6	10	12
	Z-40°C/Z+20°C	12	10	8	5	4	3	6	8	12	-
Load life (after application of the rated voltage for 2000 hours at 105°C)	Leakage current	Less than specified value									
	Capacitance change	Within ±20% of initial value									
	tanδ	Less than 200% of specified value									
Shelf life (at 105°C)	∅D	∅D ≤ 8				∅D ≥ 10					
	Life time	1000 hours				2000 hours					
After 1000 hours no load test, leakage current, capacitance and tanδ are same as load life value. The measurement shall be performed at 20°C by the KS C IEC 60384 - 4											

● DRAWING

Unit : mm

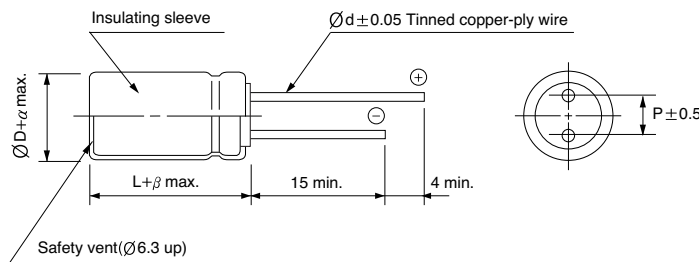

∅D	5	6.3	8	10	12.5	16	18	22		
P	2.0	2.5	3.5	5.0	5.0	7.5	7.5	10.0		
∅d	0.5	0.5	0.6	0.6	0.6	0.8	0.8	1.0		
α	0.5							1.0		
β	1.5		2.0						3.0	

● FREQUENCY COEFFICIENT OF PERMISSIBLE RIPPLE CURRENT

WV	µF	Frequency	60Hz	120Hz	1kHz	10kHz	50kHz	100kHz ≤
6.3~100		~ 47	0.75	1.00	1.55	2.00	2.00	2.00
		68 ~ 680	0.80	1.00	1.35	1.50	1.62	1.75
		820 ~	0.85	1.00	1.15	1.15	1.32	1.50
160~500		~ 220	0.80	1.00	1.40	1.60	1.70	1.80
		330 ~	0.90	1.00	1.13	1.15	1.32	1.50

MINIATURE ALUMINUM ELECTROLYTIC CAPACITORS

RD series

● DIMENSIONS & MAXIMUM PERMISSIBLE RIPPLE CURRENT

WV Item μF	6.3		10		16		25	
	∅D×L (mm)	Ripple current (mA rms) 105°C 120Hz	∅D×L (mm)	Ripple current (mA rms) 105°C 120Hz	∅D×L (mm)	Ripple current (mA rms) 105°C 120Hz	∅D×L (mm)	Ripple current (mA rms) 105°C 120Hz
68							5 × 11	108
82							6.3 × 11	137
100					5 × 11	119	6.3 × 11	151
150			5 × 11	134	6.3 × 11	167	6.3 × 11	185
220	5 × 11	146	5 × 11	162	6.3 × 11	203	6.3 × 11	224
330	6.3 × 11	206	6.3 × 11	228	6.3 × 11	248	8 × 11.5	324
470	6.3 × 11	246	6.3 × 11	272	8 × 11.5	349	8 × 11.5	386
680	8 × 11.5	348	8 × 11.5	386	8 × 11.5	420	10 × 12.5	540
820	8 × 11.5	382	10 × 12.5	493	10 × 16	587	10 × 20	708
1000	8 × 11.5	422	10 × 12.5	544	10 × 16	648	10 × 20	820
1500	10 × 16	621	10 × 16	680	10 × 20	797	12.5 × 20	1017
2200	10 × 16	713	10 × 16	774	10 × 20	898	12.5 × 20	1100
	10 × 20	778	10 × 20	844	12.5 × 20	1055	12.5 × 25	1235
3300	12.5 × 16	983	12.5 × 20	1148	12.5 × 20	1184	16 × 25	1562
4700	12.5 × 20	1219	12.5 × 20	1272	12.5 × 25	1459	16 × 25	1752
			12.5 × 25	1421	16 × 25	1657	16 × 31.5	1916
6800	12.5 × 25	1480	16 × 25	1737	16 × 25	1811	16 × 35.5	2176
					16 × 31.5	1982	18 × 35.5	2335
10000	16 × 25	1807	16 × 31.5	2172	16 × 31.5	2140	18 × 35.5	2497
15000	16 × 31.5	2128	16 × 35.5	2323	18 × 35.5	2545		
	16 × 35.5	2233	18 × 35.5	2482				
22000	18 × 31.5	2411						

WV Item μF	35		50		63		100	
	∅D×L (mm)	Ripple current (mA rms) 105°C 120Hz	∅D×L (mm)	Ripple current (mA rms) 105°C 120Hz	∅D×L (mm)	Ripple current (mA rms) 105°C 120Hz	∅D×L (mm)	Ripple current (mA rms) 105°C 120Hz
2.2			5 × 11	24	5 × 11	26		
3.3			5 × 11	29	5 × 11	32	5 × 11	32
4.7			5 × 11	35	5 × 11	38	5 × 11	38
6.8			5 × 11	42	5 × 11	46	5 × 11	46
10			5 × 11	51	5 × 11	56	5 × 11	56
15			5 × 11	62	5 × 11	68	6.3 × 11	78
22			5 × 11	75	5 × 11	83	6.3 × 11	95
33			5 × 11	92	6.3 × 11	116	8 × 11.5	139
47	5 × 11	96	6.3 × 11	127	6.3 × 11	139	10 × 12.5	190
68	6.3 × 11	132	8 × 11.5	180	8 × 11.5	197	10 × 16	251
82	6.3 × 11	145	8 × 11.5	198	8 × 11.5	216	10 × 16	290
100	6.3 × 11	160	8 × 11.5	218	8 × 11.5	239	10 × 16	304
150	8 × 11.5	231	8 × 11.5	267	10 × 12.5	340	10 × 20	406
220	8 × 11.5	280	10 × 12.5	376	10 × 16	451	12.5 × 20	564
330	10 × 12.5	400	10 × 16	504	10 × 20	603	16 × 25	856
470	10 × 16	521	10 × 20	657	12.5 × 20	844	16 × 25	1021
680	10 × 20	684	12.5 × 20	927	12.5 × 25	1107	16 × 31.5	1344
820	12.5 × 20	880	12.5 × 25	1050	16 × 25	1300	16 × 35.5	1627
1000	12.5 × 20	974	12.5 × 25	1226	16 × 25	1490	18 × 35.5	1835
1500	12.5 × 25	1136	16 × 25	1442	16 × 35.5	1770		
	16 × 20	1188	16 × 31.5	1578	18 × 31.5	1812		
2200	16 × 25	1426	16 × 31.5	1709	16 × 35.5	1891		
3300	16 × 35.5	1857	16 × 35.5	1794	18 × 40	2689		
	18 × 31.5	1900	18 × 35.5	2152				
4700	16 × 35.5	2073						
	18 × 35.5	2224						
6800	18 × 40	2510						

RD series

● DIMENSIONS & MAXIMUM PERMISSIBLE RIPPLE CURRENT

WV Item μF	160		200		250		350	
	ØD×L (mm)	Ripple current (mA rms) 105°C 120Hz	ØD×L (mm)	Ripple current (mA rms) 105°C 120Hz	ØD×L (mm)	Ripple current (mA rms) 105°C 120Hz	ØD×L (mm)	Ripple current (mA rms) 105°C 120Hz
2.2	6.3 × 11	23	6.3 × 11	23	6.3 × 11	23	6.3 × 11	23
3.3	6.3 × 11	29	6.3 × 11	29	6.3 × 11	30	8 × 11.5	34
4.7	6.3 × 11	34	6.3 × 11	34	8 × 11.5	40	8 × 11.5	40
			8 × 11.5	40			10 × 12.5	47
6.8	6.3 × 11	41	8 × 11.5	49	10 × 12.5	56	10 × 12.5	56
			10 × 12.5	56			10 × 16	62
10	8 × 11.5	59	8 × 11.5	59	10 × 12.5	68	10 × 16	75
	10 × 12.5	68	10 × 12.5	68				
15	10 × 12.5	84	10 × 12.5	84	10 × 16	92	10 × 16	92
	10 × 16	92	10 × 16	92			10 × 20	100
22	10 × 12.5	102	10 × 16	111	10 × 16	111	12.5 × 20	143
	10 × 16	111			10 × 20	121		
33	10 × 16	136	10 × 20	149	10 × 20	149	12.5 × 25	190
	10 × 20	149			12.5 × 20	175		
47	10 × 20	177	12.5 × 20	208	12.5 × 20	203	16 × 25	252
	12.5 × 20	208			12.5 × 25	227		
68	12.5 × 25	273	16 × 20	279	12.5 × 25	267	16 × 31.5	332
82	12.5 × 25	302	16 × 25	333	16 × 25	333	18 × 31.5	391
100	12.5 × 25	331	16 × 25	368	16 × 25	368	18 × 31.5	432
150	16 × 25	450	16 × 25	450	16 × 31.5	450	18 × 35.5	554
220	16 × 31.5	596	18 × 31.5	641	18 × 35.5	671	22 × 41	721
			18 × 35.5	671	18 × 40	694		
330	18 × 31.5	784	18 × 40	863	22 × 41	968		
470	18 × 40	1030	22 × 41	1155				
680	22 × 41	1390						

WV Item μF	400		450		500	
	ØD×L (mm)	Ripple current (mA rms) 105°C 120Hz	ØD×L (mm)	Ripple current (mA rms) 105°C 120Hz	ØD×L (mm)	Ripple current (mA rms) 105°C 120Hz
2.2	8 × 11.5	28	8 × 11.5	23		
3.3	8 × 11.5	34	10 × 12.5	33		
	10 × 12.5	39	10 × 16	36		
4.7	10 × 12.5	47	10 × 12.5	39	10 × 16	59
6.8	10 × 16	62	10 × 16	52	10 × 16	72
10	10 × 16	75	10 × 20	68	12.5 × 25	88
	10 × 20	82	12.5 × 20	80		
15	12.5 × 20	118	12.5 × 20	96	12.5 × 30	115
22	12.5 × 20	140	12.5 × 25	127	16 × 25	159
	12.5 × 25	155	16 × 25	144		
33	16 × 25	211	16 × 25	177	16 × 31.5	207
47	16 × 25	252	16 × 31.5	231	18 × 31.5	261
68	16 × 31.5	332	16 × 35.5	291	18 × 35.5	335
	18 × 31.5	356				
82	18 × 31.5	391	18 × 31.5	327	18 × 40	370
100	18 × 35.5	453	18 × 40	420		
150	22 × 41	596				

MINIATURE TYPES

MINIATURE ALUMINUM ELECTROLYTIC CAPACITORS

RK Wide Temperature Range, Height 7mmL Series

- Super miniature series with 7mmL height
- High performance and excellent temperature characteristics
- Wide operating temperature range of -55 ~ +105°C
- Complied to the RoHS directive

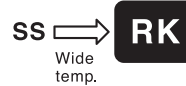
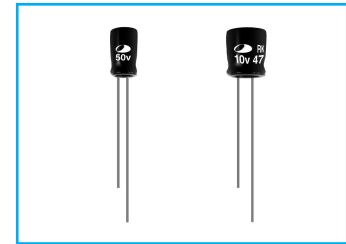

Item	Characteristics								
Operating temperature range	-55 ~ +105°C								
Leakage current max.	$I = 0.01CV$ or $3\mu A$ whichever is greater (after 1 minute)								
Capacitance tolerance	$\pm 20\%$ at 120Hz, 20°C								
Dissipation factor max. (at 120Hz, 20°C)	WV	4	6.3	10	16	25	35	50	63
	tan δ	0.35	0.22	0.19	0.15	0.12	0.12	0.10	0.10
Low temperature characteristics (Impedance ratio at 120Hz)	WV	4	6.3	10	16	25, 35	50, 63		
	Z-25°C/Z+20°C	6	4	3	2	2	2		
	Z-40°C/Z+20°C	12	10	8	6	4	3		
Load life (after application of the rated voltage for 1000 hours at 105°C)	Leakage current	Less than specified value							
	Capacitance change	Within $\pm 20\%$ of initial value							
	tan δ	Less than 200% of specified value							
Shelf life (at 105°C)	After 1000 hours no load test, leakage current, capacitance and tan δ are same as load life value. The measurement shall be performed at 20°C by the KS C IEC 60384 - 4								

● DRAWING

Unit : mm

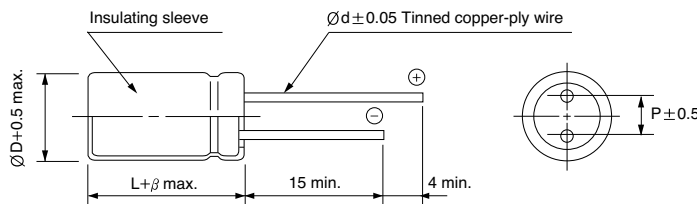

ØD	4	5	6.3
P	1.5	2.0	2.5
Ød	0.45	0.5	0.5
β	1.0	1.5	1.5

● DIMENSIONS & MAXIMUM PERMISSIBLE RIPPLE CURRENT

µF \ WV	4	6.3	10	16	25	35	50	63				
1.0							4×7	9.1	4×7	9.1		
2.2							4×7	14	5×7	16		
3.3						4×7	15	5×7	19	6.3×7	22	
4.7					4×7	18	5×7	21	6.3×7	26	6.3×7	26
6.8				4×7	19	5×7	25	5×7	25	6.3×7	32	
10			4×7	21	4×7	24	5×7	30	6.3×7	35		
22		4×7	29	5×7	36	5×7	40	6.3×7	52			
33	4×7	28	5×7	40	6.3×7	51	6.3×7	57				
47	4×7	33	5×7	47	6.3×7	60						
68	5×7	46	6.3×7	67								

Ripple current (mA rms) at 105°C, 120Hz
Case size ØD×L (mm)

● FREQUENCY COEFFICIENT OF PERMISSIBLE RIPPLE CURRENT

µF \ Frequency	60Hz	120Hz	1kHz	10kHz	50kHz	100kHz ≤
~ 47	0.75	1.00	1.55	2.00	2.00	2.00
68 ~	0.80	1.00	1.35	1.50	1.62	1.75

MINIATURE ALUMINUM ELECTROLYTIC CAPACITORS



RE Wide Temperature Range, Height 5mmL Series

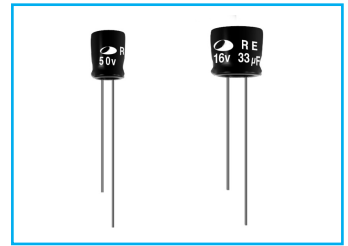
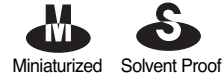

- Ultra miniature series with 5mmL height
- Wide operating temperature range of -55 ~ +105°C
- Suitable to replace tantalum capacitors at low cost
- Complied to the RoHS directive

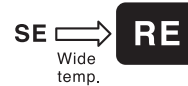

Item	Characteristics							
Operating temperature range	-55 ~ +105°C							
Leakage current max.	I = 0.01CV or 3µA whichever is greater (after 2 minutes)							
Capacitance tolerance	±20% at 120Hz, 20°C							
Dissipation factor max. (at 120Hz, 20°C)	WV	4	6.3	10	16	25	35	50
	tanδ	0.35	0.27	0.23	0.19	0.15	0.13	0.11
Low temperature characteristics (Impedance ratio at 120Hz)	WV	4	6.3	10	16	25-50		
	Z-25°C/Z+20°C	7	3	3	2	2		
	Z-40°C/Z+20°C	12	8	5	4	3		
Load life (after application of the rated voltage for 1000 hours at 105°C)	Leakage current	Less than specified value						
	Capacitance change	Within ±25% of initial value						
	tanδ	Less than 200% of specified value						
Shelf life (at 105°C)	After 1000 hours no load test, leakage current, capacitance and tanδ are same as load life value. The measurement shall be performed at 20°C by the KS C IEC 60384 - 4							

DRAWING

Unit : mm

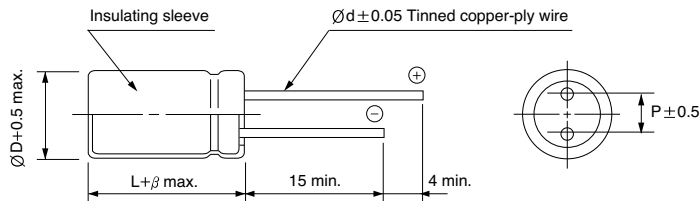

ØD	4	5	6.3	8
P	1.5	2.0	2.5	2.5
Ød	0.45	0.45	0.45	0.45
β	1.0	1.5		

DIMENSIONS & MAXIMUM PERMISSIBLE RIPPLE CURRENT

µF \ WV	4	6.3	10	16	25	35	50
1.0							4×5 7.7
1.5							4×5 9.4
2.2							4×5 11
3.3						4×5 13	4×5 14
4.7					4×5 14	4×5 15	5×5 19
6.8					4×5 17	5×5 21	5×5 23
10		4×5 15	4×5 17	4×5 18	5×5 24	5×5 26	6.3×5 33
15	4×5 17	4×5 19	4×5 21	5×5 26	5×5 29	6.3×5 37	6.3×5 40
22	4×5 20	4×5 23	5×5 29	5×5 32	6.3×5 42	6.3×5 45	8×5 58
33	4×5 25	5×5 32	5×5 35	6.3×5 45	6.3×5 51	8×5 65	8×5 71
47	4×5 29	5×5 39	6.3×5 49	6.3×5 54	8×5 72	8×5 77	
68	5×5 41	6.3×5 55	6.3×5 59	8×5 77	8×5 87		
100	5×5 50	6.3×5 66	8×5 85	8×5 93			
150	6.3×5 71	8×5 96	8×5 104				
220	8×5 102	8×5 116					

↑ ↑
Ripple current (mA rms) at 105°C, 120Hz
Case size ØD×L (mm)

FREQUENCY COEFFICIENT OF PERMISSIBLE RIPPLE CURRENT

µF \ Frequency	60Hz	120Hz	1kHz	10kHz	50kHz	100kHz ≤
~ 47	0.75	1.00	1.55	2.00	2.00	2.00
68 ~	0.80	1.00	1.35	1.50	1.62	1.75

MINIATURE ALUMINUM ELECTROLYTIC CAPACITORS

ZE High Ripple Current, Height 5mmL Series

M Miniaturized **S** Solvent Proof **IZI** Low Impedance

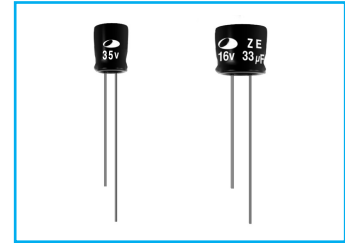

- Super miniature series with 5mmL height
- High ripple current & high temperature with RE series
- Load life of 2000 hours at 105°C
- Complied to the RoHS directive

RE → **ZE**
High Ripple

Item	Characteristics					
Operating temperature range	-55 ~ +105°C					
Leakage current	I = 0.01CV or 3µA whichever is greater (after 2 minutes) I = 0.03CV or 4µA whichever is greater (after 1 minute)					
Capacitance tolerance	±20% at 120Hz, 20°C					
Dissipation factor max. (at 120Hz, 20°C)	WV	6.3	10	16	25	35
	tanδ	0.22	0.20	0.18	0.14	0.12
Low temperature characteristics (Impedance ratio at 120Hz)	WV	6.3	10	16	25	35
	Z-25°C / Z+20°C	3	3	2	2	2
	Z-40°C / Z+20°C	9	7	5	3	3
Load life	After an application of DC bias voltage plus the rated AC ripple current for 2000 hours at 105°C. The measurement shall meet the following limits. The DC voltage plus the peak AC voltage combined must not exceed the rated voltage.					
	Leakage current	Less than specified value				
	Capacitance change	Within ±20% of the initial value				
	tanδ	Less than 200% of the specified value				
Shelf life (at 105°C)	After 1000 hours no load test, leakage current, capacitance and tanδ are same as load life value. The measurement shall be performed at 20°C by the KS C IEC 60384 - 4					

● DRAWING

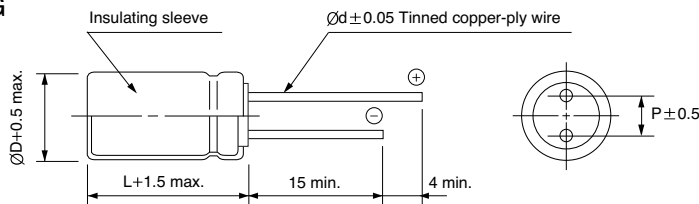

Unit : mm

ØD	5	6.3
P	2.0	2.5
Ød	0.45	0.45

● DIMENSIONS & MAXIMUM PERMISSIBLE RIPPLE CURRENT

WV Item µF	6.3			10			16			25			35		
	ØD × L (mm)	Imp.(Ω) max. 20°C 100kHz	Ripple current (mA rms) 105°C 100kHz	ØD × L (mm)	Imp.(Ω) max. 20°C 100kHz	Ripple current (mA rms) 105°C 100kHz	ØD × L (mm)	Imp.(Ω) max. 20°C 100kHz	Ripple current (mA rms) 105°C 100kHz	ØD × L (mm)	Imp.(Ω) max. 20°C 100kHz	Ripple current (mA rms) 105°C 100kHz	ØD × L (mm)	Imp.(Ω) max. 20°C 100kHz	Ripple current (mA rms) 105°C 100kHz
1													5×5	2.40	100
1.5													5×5	2.40	100
2.2													5×5	2.40	100
3.3													5×5	2.40	100
4.7													5×5	2.40	100
6.8													5×5	2.40	100
10									5×5	2.40	100	5×5	2.40	100	
15							5×5	2.40	100	5×5	2.40	100	5×5	2.40	100
22							5×5	2.40	100	5×5	2.40	100	6.3×5	0.75	140
33	5×5	2.40	100	5×5	2.40	100	5×5	2.40	100	6.3×5	0.75	140	6.3×5	0.75	140
47	5×5	2.40	100	5×5	2.40	100	6.3×5	0.75	140	6.3×5	0.75	140			
68	6.3×5	0.75	140	6.3×5	0.75	140	6.3×5	0.75	140						
100	6.3×5	0.75	140	6.3×5	0.75	140									

● FREQUENCY COEFFICIENT OF PERMISSIBLE RIPPLE CURRENT

µF	Frequency	120Hz	1kHz	10kHz	50kHz	100kHz ≤
~ 33		0.35	0.55	0.75	0.87	1.00
47 ~		0.40	0.60	0.80	0.90	1.00

MINIATURE ALUMINUM ELECTROLYTIC CAPACITORS



ZS High Ripple Current, Height 7mmL Series

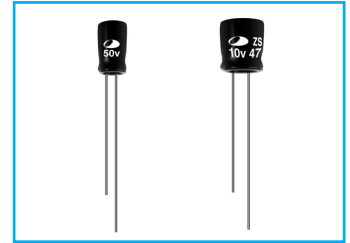

- Super miniature series with 7mmL height
- High ripple current compared with RK series
- Load life of 2000 hours at 105°C
- Complied to the RoHS directive

Item	Characteristics						
Operating temperature range	-40 ~ +105°C						
Leakage current	I = 0.01CV or 3μA whichever is greater (after 2 minutes) I = 0.03CV or 4μA whichever is greater (after 1 minute)						
Capacitance tolerance	±20% at 120Hz, 20°C						
Dissipation factor max. (at 120Hz, 20°C)	WV	6.3	10	16	25	35	50
	tanδ	0.22	0.19	0.16	0.14	0.12	0.10
Low temperature characteristics (Impedance ratio at 120Hz)	WV	6.3	10	16	25	35	50
	Z-25°C / Z+20°C	2	2	2	2	2	2
	Z-40°C / Z+20°C	6	4	3	3	3	3
Load life	After an application of DC bias voltage plus the rated AC ripple current for 2000 hours at 105°C. The measurement shall meet the following limits. The DC voltage plus the peak AC voltage combined must not exceed the rated voltage.						
	Leakage current	Less than specified value					
	Capacitance change	Within ±25% of the initial value					
	tanδ	Less than 200% of the specified value					
Shelf life (at 105°C)	After 1000 hours no load test, leakage current, capacitance and tanδ are same as load life value. The measurement shall be performed at 20°C by the KS C IEC 60384 - 4						

DRAWING

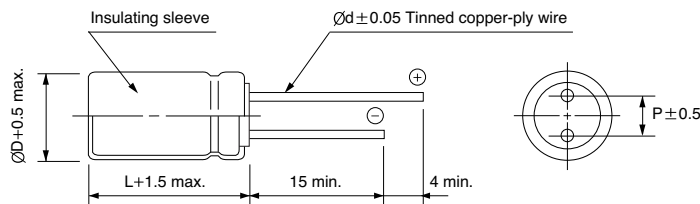

Unit : mm

ØD	5	6.3	8
P	2.0	2.5	3.5
Ød	0.5	0.5	0.5

DIMENSIONS & MAXIMUM PERMISSIBLE RIPPLE CURRENT

WV	6.3		10		16		25		35		50							
	Item	ØD×L (mm)	Imp.(Ω) max. 20°C 100kHz	Ripple current (mA rms) 105°C 100kHz	ØD×L (mm)	Imp.(Ω) max. 20°C 100kHz	Ripple current (mA rms) 105°C 100kHz	ØD×L (mm)	Imp.(Ω) max. 20°C 100kHz	Ripple current (mA rms) 105°C 100kHz	ØD×L (mm)	Imp.(Ω) max. 20°C 100kHz	Ripple current (mA rms) 105°C 100kHz					
2.2													5×7	2.00	165			
4.7														5×7	2.00	165		
10														6.3×7	0.90	235		
22											5×7	1.40	165	6.3×7	0.90	260		
33	5×7	1.40	165	5×7	1.40	165	5×7	1.40	165	5×7	1.40	165	6.3×7	0.70	235	8×7	0.50	350
47	5×7	1.40	165	5×7	1.40	165	5×7	1.40	165	6.3×7	0.70	235	8×7	0.34	350	8×7	0.50	450
68	6.3×7	0.70	235	6.3×7	0.70	235	6.3×7	0.70	235	6.3×7	0.70	235	8×7	0.34	350			
100	6.3×7	0.70	235	6.3×7	0.70	235	6.3×7	0.70	235	8×7	0.34	350						
150	6.3×7	0.70	235	6.3×7	0.70	235	8×7	0.34	350									
220	8×7	0.34	350	8×7	0.34	350												
330	8×7	0.34	350															

FREQUENCY COEFFICIENT OF PERMISSIBLE RIPPLE CURRENT

µF	Frequency	120Hz	1kHz	10kHz	50kHz	100kHz ≤
~ 33		0.35	0.55	0.75	0.87	1.00
47 ~ 150		0.40	0.60	0.80	0.90	1.00
220 ~		0.50	0.65	0.85	0.92	1.00

MINIATURE TYPES

MINIATURE ALUMINUM ELECTROLYTIC CAPACITORS

ZL High Ripple Current, Height 7mmL Series

M Miniaturized **S** Solvent Proof **ZL** Low Impedance

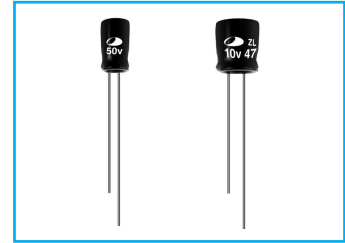

- Super miniature series with 7mmL height
- Load life of 3000 hours at 105°C
- Complied to the RoHS directive

ZS → **ZL**
High Ripple

Item	Characteristics						
Operating temperature range	-40 ~ +105°C						
Leakage current	I = 0.01CV or 3μA whichever is greater (after 2 minutes) I = 0.03CV or 4μA whichever is greater (after 1 minute)						
Capacitance tolerance	±20% at 120Hz, 20°C						
Dissipation factor max. (at 120Hz, 20°C)	WV	6.3	10	16	25	35	50
	tanδ	0.22	0.19	0.16	0.14	0.12	0.10
Low temperature characteristics (Impedance ratio at 120Hz)	WV	6.3	10	16	25	35	50
	Z-25°C / Z+20°C	2	2	2	2	2	2
	Z-40°C / Z+20°C	6	4	3	3	3	3
Load life	After an application of DC bias voltage plus the rated AC ripple current for 3000 hours at 105°C. The measurement shall meet the following limits. The DC voltage plus the peak AC voltage combined must not exceed the rated voltage.						
	Leakage current	Less than specified value					
	Capacitance change	Within ±25% of the initial value					
	tanδ	Less than 200% of the specified value					
Shelf life (at 105°C)	After 1000 hours no load test, leakage current, capacitance and tanδ are same as load life value. The measurement shall be performed at 20°C by the KS C IEC 60384 - 4						

● DRAWING

Unit : mm

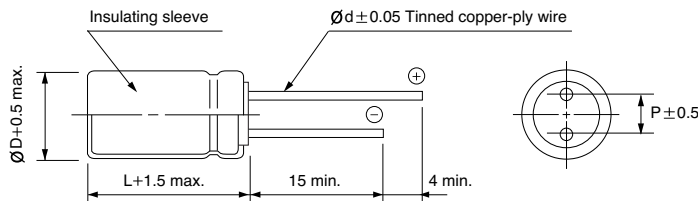

ØD	5	6.3	8
P	2.0	2.5	3.5
Ød	0.5	0.5	0.5

● DIMENSIONS & MAXIMUM PERMISSIBLE RIPPLE CURRENT

WV Item μF	6.3		10		16		25		35		50							
	ØD×L (mm)	Imp.(Ω) max. 20°C 100kHz	Ripple current (mA rms) 105°C 100kHz	ØD×L (mm)	Imp.(Ω) max. 20°C 100kHz	Ripple current (mA rms) 105°C 100kHz	ØD×L (mm)	Imp.(Ω) max. 20°C 100kHz	Ripple current (mA rms) 105°C 100kHz	ØD×L (mm)	Imp.(Ω) max. 20°C 100kHz	Ripple current (mA rms) 105°C 100kHz						
2.2												5×7	1.00	165				
10												6.3×7	0.45	235				
22										5×7	0.84	165	6.3×7	0.45	235			
33	5×7	0.84	165	5×7	0.84	165	5×7	0.84	165	5×7	0.84	165	6.3×7	0.42	235	8×7	0.30	350
47	5×7	0.84	165	5×7	0.84	165	5×7	0.84	165	6.3×7	0.42	235	8×7	0.20	350	8×7	0.25	350
68	6.3×7	0.42	235	6.3×7	0.42	235	6.3×7	0.42	235	6.3×7	0.42	235	8×7	0.20	350			
100	6.3×7	0.42	235	6.3×7	0.42	235	6.3×7	0.42	235	8×7	0.20	350						
150	6.3×7	0.42	235	6.3×7	0.42	235	8×7	0.20	350									
220	8×7	0.20	350	8×7	0.20	350												
330	8×7	0.20	350															

● FREQUENCY COEFFICIENT OF PERMISSIBLE RIPPLE CURRENT (See page 97)

MINIATURE ALUMINUM ELECTROLYTIC CAPACITORS



ZT Long Life, Height 7mmL Series

- Super miniature series with 7mmL height
- Load life of 5000 hours at 105°C
- Complied to the RoHS directive, Halogen-Free

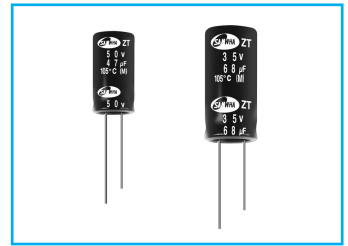

Item	Characteristics						
Operating temperature range	-40 ~ +105°C						
Leakage current max.	I = 0.01CV or 3μA (after 2 minutes)						
Capacitance tolerance	±20% at 120Hz, 20°C						
Dissipation factor max. (at 120Hz, 20°C)	WV	6.3	10	16	25	35	50
	tanδ	0.40	0.35	0.30	0.25	0.20	0.20
Low temperature characteristics (Impedance ratio at 120Hz)	WV	6.3	10	16	25	35	50
	Z-25°C/Z+20°C	6	4	4	3	3	3
	Z-40°C/Z+20°C	12	10	8	6	6	6
Load life (after application of the rated voltage for 5000 hours at 105°C)	Leakage current	Less than specified value					
	Capacitance change	Within ±30% of initial value					
	tanδ	Less than 300% of specified value					
Shelf life (at 105°C)	After 1000 hours no load test, leakage current, capacitance and tanδ are same as load life value. The measurement shall be performed at 20°C by the KS C IEC 60384 - 4						

DRAWING

Unit : mm

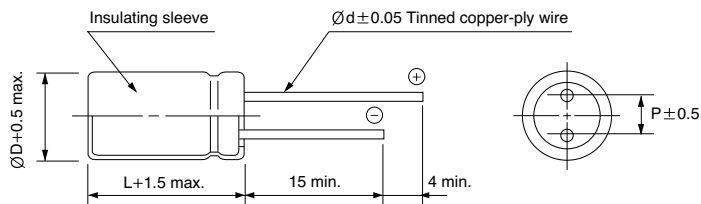

ØD	5	6.3	8
P	2.0	2.5	3.5
Ød	0.5	0.5	0.5

DIMENSIONS & MAXIMUM PERMISSIBLE RIPPLE CURRENT

μF \ WV	6.3	10	16	25	35	50
2.2						5×7 165
10						6.3×7 235
22					5×7 165	6.3×7 260
33	5×7 165	5×7 165	5×7 165	5×7 165	6.3×7 235	8×7 350
47	5×7 165	5×7 165	5×7 165	6.3×7 235	8×7 350	8×7 450
68	6.3×7 235	6.3×7 235	6.3×7 235	6.3×7 235	8×7 350	
100	6.3×7 235	6.3×7 235	6.3×7 235	8×7 350		
150	6.3×7 235	6.3×7 235	8×7 350			
220	8×7 350	8×7 350				
330	8×7 350					

↑↑
 Ripple current (mA rms) at 105°C, 100kHz
 Case size ØD×L (mm)

FREQUENCY COEFFICIENT OF PERMISSIBLE RIPPLE CURRENT

μF \ Frequency	120Hz	1kHz	10kHz	50kHz	100kHz ≤
~ 33	0.25	0.50	0.75	0.90	1.00
47 ~	0.30	0.55	0.80	0.90	1.00

MINIATURE ALUMINUM ELECTROLYTIC CAPACITORS

WL Low Impedance Series

LL Long Life
S Solvent Proof WV ≤ 100V
IZI Low Impedance

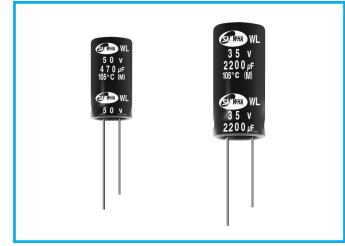

- Wide voltage compared with RZ series
- Operating temperature range of -40 ~ +105°C
- Low impedance at high frequency
- High reliability withstanding 5000 hours load life at 105°C
- For E-meter
- Complied to the RoHS directive

WL ⇒ **WF**
Long life

Item	Characteristics										
Operating temperature range	WV	6.3 ~ 450									
	Temperature range	-40 ~ +105°C									
Leakage current max.	WV ≤ 100	WV > 100									
	I = 0.01CV or 3µA whichever is greater (after 2 min.) I = 0.03CV or 4µA whichever is greater (after 1 min.)										
Capacitance tolerance	±20% at 120Hz, 20°C										
Dissipation factor max. (at 120Hz, 20°C)	Capacitance > 1000µF : tanδ increases by 0.02 for each 1000µF from below value.										
	WV	6.3	10	16	25	35	50	63	100	160~250	350~500
	tanδ	0.22	0.19	0.16	0.14	0.12	0.10	0.09	0.08	0.15	0.20
Low temperature characteristics (Impedance ratio at 120Hz)	WV	6.3	10	16	25 ~ 100	160 ~ 250	350 ~ 450	500			
	Z-25°C/Z+20°C	4	3	2	2	3	6	8			
	Z-40°C/Z+20°C	8	6	4	3	4	10	-			
Load life	After an application of DC bias voltage plus the rated AC ripple current for 5000 hours at 105°C. The measurement shall meet the following limits. The DC voltage plus the peak AC voltage combined must not exceed the rated voltage.										
	Leakage current	Less than specified value									
	Capacitance change	Within ±25% of initial value									
	tanδ	Less than 200% of specified value									
	Life time	∅D = 5, 6.3			∅D = 8			∅D ≥ 10			
WV ≤ 100	2000 hours			3000 hours			5000 hours				
WV > 100	2000 hours										
Shelf life (at 105°C)	After 1000 hours no load test, leakage current, capacitance and tanδ are same as load life value. The measurement shall be performed at 20°C by the KS C IEC 60384 - 4										

● DRAWING

Unit : mm

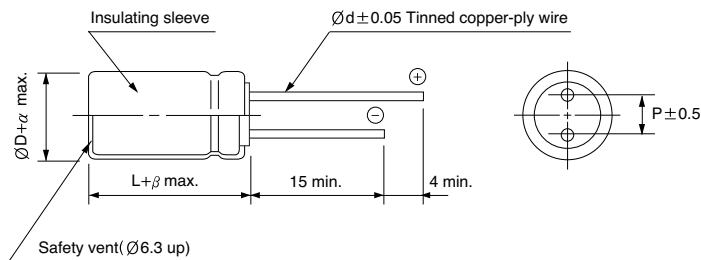

∅D	5	6.3	8	10	12.5	16	18	20	22
P	2.0	2.5	3.5	5.0	5.0	7.5	7.5	10.0	10.0
∅d	0.5	0.5	0.6	0.6	0.6	0.8	0.8	0.8	1.0
α	0.5							1.0	
β	1.5		2.0				3.0		

● FREQUENCY COEFFICIENT OF PERMISSIBLE RIPPLE CURRENT

µF	Frequency	120Hz	1kHz	10kHz	50kHz	100kHz ≤
~ 33		0.40	0.65	0.82	0.91	1.00
47 ~ 220		0.50	0.70	0.84	0.92	1.00
330 ~ 680		0.55	0.75	0.86	0.93	1.00
820 ~ 1500		0.60	0.80	0.88	0.94	1.00
2200 ~		0.70	0.85	0.90	0.95	1.00

WL series

● DIMENSIONS & MAXIMUM PERMISSIBLE RIPPLE CURRENT

WV Item μF	6.3			10			16			25		
	ØD×L (mm)	Impedance (Ω)max. 20°C 100kHz	Ripple current (mA rms) 105°C 100kHz	ØD×L (mm)	Impedance (Ω)max. 20°C 100kHz	Ripple current (mA rms) 105°C 100kHz	ØD×L (mm)	Impedance (Ω)max. 20°C 100kHz	Ripple current (mA rms) 105°C 100kHz	ØD×L (mm)	Impedance (Ω)max. 20°C 100kHz	Ripple current (mA rms) 105°C 100kHz
10							5×11	0.90	180	5×11	0.90	180
22	5×11	0.70	180	5×11	0.70	180	5×11	0.70	180	5×11	0.70	180
33	5×11	0.70	180	5×11	0.70	180	5×11	0.70	180	5×11	0.70	180
47	5×11	0.65	180	5×11	0.65	180	5×11	0.65	180	5×11	0.65	180
100	5×11	0.65	180	5×11	0.65	180	6.3×11	0.30	280	6.3×11	0.30	280
150	6.3×11	0.30	280	6.3×11	0.30	280	6.3×11	0.30	280	8×11.5	0.20	450
220	6.3×11	0.30	280	6.3×11	0.30	280	8×11.5	0.14	450	8×11.5	0.20	450
330	6.3×11	0.30	280	8×11.5	0.14	450	8×11.5	0.14	450	10×12.5	0.10	660
470	8×11.5	0.14	450	8×11.5	0.14	450	10×12.5	0.10	660	10×16	0.080	850
680	10×12.5	0.10	660	10×12.5	0.10	660	10×16	0.080	850	10×20	0.054	1100
1000	10×12.5	0.10	660	10×16	0.080	850	10×20	0.054	1100	12.5×20	0.050	1400
1500	10×20	0.054	1100	10×20	0.054	1100	12.5×20	0.050	1400	16×20	0.030	2100
2200	12.5×20	0.050	1400	12.5×20	0.050	1400	12.5×25	0.038	1700	16×25	0.030	2100
3300	12.5×20	0.050	1400	12.5×25	0.038	1700	16×25	0.030	2100	16×31.5	0.025	2600
4700	16×25	0.030	2100	16×25	0.030	2100	16×31.5	0.025	2600	18×35.5	0.022	3000
6800	16×25	0.030	2100	16×31.5	0.025	2600	18×35.5	0.022	3000			
10000	16×31.5	0.025	2600	18×35.5	0.022	3000						
15000	18×35.5	0.022	3000									

WV Item μF	35			50			63			100		
	ØD×L (mm)	Impedance (Ω)max. 20°C 100kHz	Ripple current (mA rms) 105°C 100kHz	ØD×L (mm)	Impedance (Ω)max. 20°C 100kHz	Ripple current (mA rms) 105°C 100kHz	ØD×L (mm)	Impedance (Ω)max. 20°C 100kHz	Ripple current (mA rms) 105°C 100kHz	ØD×L (mm)	Impedance (Ω)max. 20°C 100kHz	Ripple current (mA rms) 105°C 100kHz
1.0				5×11	3.0	40						
2.2				5×11	3.0	55				5×11	2.5	52
3.3				5×11	2.6	65	5×11	2.0	64	5×11	2.5	64
4.7	5×11	0.90	180	5×11	2.3	90	5×11	2.0	76	5×11	2.5	76
10	5×11	0.90	180	5×11	1.4	120	5×11	2.0	111	6.3×11	1.0	128
22	5×11	0.70	180	5×11	1.2	150	6.3×11	0.60	190	8×11.5	0.60	224
33	5×11	0.65	180	6.3×11	0.60	200	6.3×11	0.60	233	10×12.5	0.40	319
47	6.3×11	0.30	280	6.3×11	0.43	250	8×11.5	0.50	328	10×16	0.30	417
100	8×11.5	0.20	450	8×11.5	0.24	340	10×16	0.12	456	12.5×20	0.15	570
150	8×11.5	0.14	450	10×12.5	0.17	490	10×20	0.10	610	12.5×25	0.12	762
220	10×12.5	0.10	660	10×16	0.12	650	12.5×20	0.090	809	16×25	0.070	1250
330	10×16	0.080	850	10×20	0.10	810	12.5×20	0.085	1036	16×31.5	0.050	1404
470	10×20	0.054	1100	12.5×20	0.085	1100	16×20	0.050	1411	18×40	0.030	1980
680	12.5×20	0.050	1400	12.5×25	0.065	1200	16×25	0.043	1843	18×40	0.030	2050
820	12.5×25	0.045	1500	16×25	0.055	1300	18×25	0.035	1900	18×40	0.030	2215
1000	12.5×25	0.038	1700	16×25	0.043	1600	16×35.5	0.025	1967			
1500	16×25	0.030	2100	16×31.5	0.038	2000						
2200	16×31.5	0.025	2600	18×35.5	0.034	2300						
3300	18×35.5	0.022	3000									

MINIATURE TYPES

MINIATURE ALUMINUM ELECTROLYTIC CAPACITORS

WL series

● DIMENSIONS & MAXIMUM PERMISSIBLE RIPPLE CURRENT

WV Item μF	160		200		250		350	
	$\varnothing\text{D} \times \text{L}$ (mm)	Ripple current (mA rms) 105°C 100kHz	$\varnothing\text{D} \times \text{L}$ (mm)	Ripple current (mA rms) 105°C 100kHz	$\varnothing\text{D} \times \text{L}$ (mm)	Ripple current (mA rms) 105°C 100kHz	$\varnothing\text{D} \times \text{L}$ (mm)	Ripple current (mA rms) 105°C 100kHz
1	6.3×11	45						
10	10×12.5	230			10×16	300	10×16	180
22	10×16	440	10×20	440	10×20	480	12.5×20	270
33	10×16	560	12.5×20	590	12.5×20	630	16×20	600
47	10×20	725	12.5×20	780	12.5×25	630	16×25	700
68	12.5×25	950	12.5×25	950	16×25	1000	16×31.5	1100
82					16×25	1100	16×35.5	1130
100	16×25	1280	16×25	1280	16×31.5	1400	18×31.5	1170
120							18×35.5	1200
150	16×25	1300	16×25	1500	18×25 18×31.5	1450	18×40	1250
220	16×31.5	1500	18×31.5	1700	18×35.5 18×40	1485		
330	18×31.5	1700	18×35.5	1900				

WV Item μF	400		420		450		500	
	$\varnothing\text{D} \times \text{L}$ (mm)	Ripple current (mA rms) 105°C 100kHz	$\varnothing\text{D} \times \text{L}$ (mm)	Ripple current (mA rms) 105°C 100kHz	$\varnothing\text{D} \times \text{L}$ (mm)	Ripple current (mA rms) 105°C 100kHz	$\varnothing\text{D} \times \text{L}$ (mm)	Ripple current (mA rms) 105°C 100kHz
3.3					10×12.5	150		
4.7					10×16	200		
10	10×16	176			10×16	230	12.5×20	240
22	12.5×25	300			12.5×25	525	12.5×30	420
33	16×20	600			16×25	600	16×31.5	560
47	16×25	700	16×25	630	16×25 16×31.5 18×25	660 720 720	16×35.5 18×31.5 18×35.5	650 620 700
56			16×31.5 18×25	740	16×31.5 18×25	800 800	16×40	740
68	16×31.5	1100	16×35.5 18×25	810	16×35.5 18×31.5	900 900	16×45 18×40	820 900
82	16×35.5	1150	16×40 18×31.5	960 900	16×40 18×31.5 18×35.5	1115 1115 1200	16×50 18×40	1000 1000
100	18×35.5	1200	16×40 18×35.5	1100	16×40 18×35.5	1300	16×50 18×45 20×41	1250 1250 1250
120	18×40	1270	16×50 18×40	1250 1200	16×50 18×40	1500 1500	22×45	1370
150	20×41	1380			20×41	1600		

MD High Ripple Current, Ultra Low Impedance Series

IZI Low Impedance **S** Solvent Proof

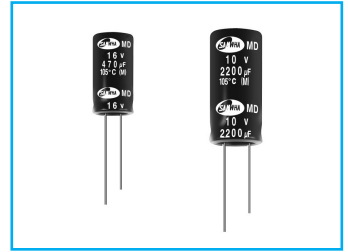

- High ripple current compared with MZ series
- Enabled ripple current with extremely low impedance at high frequency range
- High reliability withstanding 2000 hours load life at 105°C
- Complied to the RoHS directive

MZ → MD
High Ripple

Item	Characteristics			
Operating temperature range	-40 ~ +105°C			
Leakage current max.	I = 0.01CV or 3 μ A whichever is greater (after 2 minutes) I = 0.03CV or 4 μ A whichever is greater (after 1 minute)			
Capacitance tolerance	\pm 20% at 120Hz, 20°C			
Dissipation factor max. (at 120Hz, 20°C)	Capacitance > 1000 μ F : $\tan\delta$ increases by 0.02 for each 1000 μ F from below value.			
	WV	6.3	10	16
Low temperature characteristics (Impedance ratio at 120Hz)	$\tan\delta$	0.22	0.19	0.16
	WV	6.3	10	16
Load life	Z-40°C / Z+20°C	3	3	3
	After an application of DC bias voltage plus the rated AC ripple current for 2000 hours at 105°C. The measurement shall meet the following limits. The DC voltage plus the peak AC voltage combined must not exceed the rated voltage.			
Shelf life (at 105°C)	Leakage current	Less than specified value		
	Capacitance change	Within \pm 25% of initial value		
	$\tan\delta$	Less than 200% of specified value		
After 1000 hours no load test, leakage current, capacitance and $\tan\delta$ are same as load life value. The measurement shall be performed at 20°C by the KS C IEC 60384 - 4				

● DRAWING (See page 87)

● DIMENSIONS & MAXIMUM PERMISSIBLE RIPPLE CURRENT

Item μ F	WV	6.3		10			16		
	$\varnothing D \times L$ (mm)	Impedance (Ω)max. 20°C 100kHz	Ripple current (mA rms) 105°C 100kHz	$\varnothing D \times L$ (mm)	Impedance (Ω)max. 20°C 100kHz	Ripple current (mA rms) 105°C 100kHz	$\varnothing D \times L$ (mm)	Impedance (Ω)max. 20°C 100kHz	Ripple current (mA rms) 105°C 100kHz
470							8 × 11.5	0.021	1340
680				8 × 11.5	0.021	1340	8 × 15	0.020	1850
							10 × 12.5	0.020	1960
820	8 × 11.5	0.021	1340						
1000				8 × 15	0.020	1850	8 × 20	0.016	2350
				10 × 12.5	0.016	1960	10 × 16	0.016	2460
1500	10 × 12.5	0.016	1960	8 × 20	0.013	2350	10 × 20	0.014	2805
				10 × 16	0.013	2460			
1800	10 × 16	0.013	2460	10 × 20	0.011	2805	12.5 × 20	0.013	3230
2200	10 × 20	0.011	2805	12.5 × 20	0.009	3230			
3300	12.5 × 20	0.009	3230						

● FREQUENCY COEFFICIENT OF PERMISSIBLE RIPPLE CURRENT

μ F	Frequency	120Hz	1kHz	10kHz	50kHz	100kHz \leq
~ 820		0.55	0.77	0.94	0.97	1.00
1000 ~ 1800		0.60	0.80	0.96	0.98	1.00
2200 ~		0.70	0.85	0.98	0.99	1.00

MINIATURE ALUMINUM ELECTROLYTIC CAPACITORS

RZ Low Impedance Series

 Long Life
  Solvent Proof
  Low Impedance

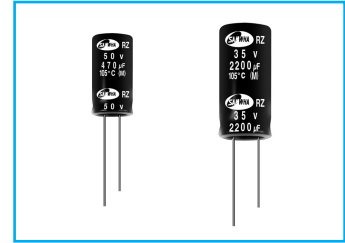

- Low impedance at high frequency
- High reliability withstanding 5000 hours load life at 105°C (2000/3000 hours for smaller case sizes as specified below)
- Ideally suited for use in switching power supplies
- Complied to the RoHS directive

 \Rightarrow 
 Long life

Item	Characteristics															
Operating temperature range	-55 ~ +105°C															
Leakage current max.	I = 0.01CV or 3µA whichever is greater (after 2 minutes) I = 0.03CV or 4µA whichever is greater (after 1 minute)															
Capacitance tolerance	±20% at 120Hz, 20°C															
Dissipation factor max. (at 120Hz, 20°C)	Capacitance > 1000µF : tanδ increases by 0.02 for each 1000µF from below value															
	<table border="1"> <tr> <td>WV</td> <td>6.3</td> <td>10</td> <td>16</td> <td>25</td> <td>35</td> <td>50</td> <td>63</td> </tr> <tr> <td>tanδ</td> <td>0.22</td> <td>0.19</td> <td>0.16</td> <td>0.14</td> <td>0.12</td> <td>0.10</td> <td>0.08</td> </tr> </table>	WV	6.3	10	16	25	35	50	63	tanδ	0.22	0.19	0.16	0.14	0.12	0.10
WV	6.3	10	16	25	35	50	63									
tanδ	0.22	0.19	0.16	0.14	0.12	0.10	0.08									
Low temperature characteristics (Impedance ratio at 120Hz)	<table border="1"> <tr> <td>WV</td> <td>6.3, 10</td> <td>16 ~ 35</td> <td>50, 63</td> </tr> <tr> <td>Z-55°C/Z+20°C</td> <td>4</td> <td>3</td> <td>2</td> </tr> </table>	WV	6.3, 10	16 ~ 35	50, 63	Z-55°C/Z+20°C	4	3	2							
	WV	6.3, 10	16 ~ 35	50, 63												
Z-55°C/Z+20°C	4	3	2													
Load life	After an application of DC bias voltage plus the rated AC ripple current for 5000 hours at 105°C. The measurement shall meet the following limits. The DC voltage plus the peak AC voltage combined must not exceed the rated voltage.															
	<table border="1"> <tr> <td>Leakage current</td> <td>Less than specified value</td> </tr> <tr> <td>Capacitance change</td> <td>Within ±20% of initial value</td> </tr> <tr> <td>tanδ</td> <td>Less than 200% of specified value</td> </tr> </table>	Leakage current	Less than specified value	Capacitance change	Within ±20% of initial value	tanδ	Less than 200% of specified value									
	Leakage current	Less than specified value														
	Capacitance change	Within ±20% of initial value														
tanδ	Less than 200% of specified value															
<table border="1"> <tr> <td>∅D</td> <td>∅D ≤ 6.3</td> <td>∅D = 8</td> <td>∅D ≥ 10</td> </tr> <tr> <td>Life time</td> <td>2000 hours</td> <td>3000 hours</td> <td>5000 hours</td> </tr> </table>	∅D	∅D ≤ 6.3	∅D = 8	∅D ≥ 10	Life time	2000 hours	3000 hours	5000 hours								
∅D	∅D ≤ 6.3	∅D = 8	∅D ≥ 10													
Life time	2000 hours	3000 hours	5000 hours													
After 1000 hours no load test, leakage current, capacitance and tanδ are same as load life value. The measurement shall be performed at 20°C by the KS C IEC 60384 - 4																
Shelf life (at 105°C)	<table border="1"> <tr> <td>Leakage current</td> <td>Less than specified value</td> </tr> <tr> <td>Capacitance change</td> <td>Within ±20% of initial value</td> </tr> <tr> <td>tanδ</td> <td>Less than 150% of specified value</td> </tr> </table>	Leakage current	Less than specified value	Capacitance change	Within ±20% of initial value	tanδ	Less than 150% of specified value									
	Leakage current	Less than specified value														
	Capacitance change	Within ±20% of initial value														
tanδ	Less than 150% of specified value															

● DRAWING

Unit : mm

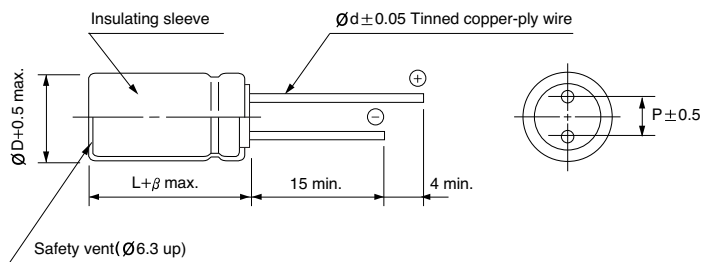

∅D	5	6.3	8	10	12.5	16	18
P	2.0	2.5	3.5	5.0	5.0	7.5	7.5
∅d	0.5	0.5	0.6	0.6	0.6	0.8	0.8
β	1.5			2.0			

● FREQUENCY COEFFICIENT OF PERMISSIBLE RIPPLE CURRENT

µF \ Frequency	120Hz	1kHz	10kHz	50kHz	100kHz ≤
~ 33	0.40	0.65	0.82	0.91	1.00
47 ~ 220	0.50	0.70	0.84	0.92	1.00
330 ~ 680	0.55	0.75	0.86	0.93	1.00
1000 ~ 1500	0.60	0.80	0.88	0.94	1.00
2200 ~	0.70	0.85	0.90	0.95	1.00

RZ series

● DIMENSIONS & MAXIMUM PERMISSIBLE RIPPLE CURRENT

WV Item μF	6.3			10			16			25		
	∅D×L (mm)	Impedance (Ω)max. 20°C 100kHz	Ripple current (mA rms) 105°C 100kHz	∅D×L (mm)	Impedance (Ω)max. 20°C 100kHz	Ripple current (mA rms) 105°C 100kHz	∅D×L (mm)	Impedance (Ω)max. 20°C 100kHz	Ripple current (mA rms) 105°C 100kHz	∅D×L (mm)	Impedance (Ω)max. 20°C 100kHz	Ripple current (mA rms) 105°C 100kHz
33										5×11	0.80	155
47							5×11	0.80	155	6.3×11	0.55	210
68				5×11	0.80	155	6.3×11	0.50	220	6.3×11	0.36	260
100	5×11	0.85	150	6.3×11	0.55	210	6.3×11	0.35	265	8×11.5	0.24	383
150	6.3×11	0.49	225	6.3×11	0.35	265	8×11.5	0.23	388	8×11.5	0.16	460
220	6.3×11	0.30	285	8×11.5	0.24	387	8×11.5	0.16	460	10×12.5	0.13	600
330	8×11.5	0.20	292	8×11.5	0.16	460	10×12.5	0.12	625	10×16	0.095	750
470	10×12.5	0.14	575	10×12.5	0.13	600	10×16	0.09	770	10×20	0.065	1020
680	10×16	0.11	700	10×16	0.09	770	10×20	0.065	1020	12.5×20	0.046	1392
1000	10×20	0.075	950	10×20	0.060	1060	12.5×20	0.047	1411	12.5×25	0.036	1660
1500	12.5×20	0.055	1220	12.5×20	0.045	1417	12.5×25	0.036	1660	16×20	0.034	1770
2200	12.5×20	0.043	1438	12.5×25	0.034	1710	16×20	0.033	1800	16×25	0.028	2051
3300	12.5×25	0.034	1710	16×20	0.031	1850	16×25	0.027	2095	16×35.5	0.020	2680
4700	16×25	0.032	1935	16×31.5	0.023	2420	16×35.5	0.020	2680	18×40	0.018	2960
6800	16×31.5	0.024	2370	16×35.5	0.020	2680	18×35.5	0.018	2900			
10000	16×40	0.020	2750	18×40	0.017	3040						
15000	18×40	0.018	2960									

WV Item μF	35			50			63		
	∅D×L (mm)	Impedance (Ω)max. 20°C 100kHz	Ripple current (mA rms) 105°C 100kHz	∅D×L (mm)	Impedance (Ω)max. 20°C 100kHz	Ripple current (mA rms) 105°C 100kHz	∅D×L (mm)	Impedance (Ω)max. 20°C 100kHz	Ripple current (mA rms) 105°C 100kHz
1.0				5 × 11	4.00	36			
1.5				5 × 11	3.80	45			
2.2				5 × 11	3.50	54			
3.3				5 × 11	3.00	66			
4.7				5 × 11	2.20	81			
6.8				5 × 11	1.80	91			
10				5 × 11	1.80	115	5 × 11	1.80	135
15				5 × 11	1.60	145	6.3 × 11	1.00	185
22	5 × 11	0.75	160	6.3 × 11	1.40	195	6.3 × 11	1.00	215
33	6.3 × 11	0.49	225	6.3 × 11	1.20	240	8 × 11.5	0.80	320
47	6.3 × 11	0.34	270	8 × 11.5	0.80	344	8 × 11.5	0.80	365
68	8 × 11.5	0.24	384	8 × 11.5	0.65	410	10 × 12.5	0.23	495
100	8 × 11.5	0.16	460	10 × 16	0.40	581	10 × 20	0.16	750
150	10 × 12.5	0.12	625	10 × 20	0.30	820	12.5 × 20	0.12	950
220	10 × 16	0.09	770	12.5 × 20	0.20	1040	12.5 × 20	0.085	1140
330	10 × 20	0.060	1060	12.5 × 20	0.12	1281	12.5 × 25	0.060	1420
470	12.5 × 20	0.046	1401	12.5 × 25	0.085	1500	16 × 25	0.055	1700
680	12.5 × 25	0.036	1660	16 × 20	0.060	1630	16 × 31.5	0.032	2050
1000	16 × 20	0.034	1770	16 × 31.5	0.040	2120	18 × 35.5	0.029	2280
1500	16 × 31.5	0.028	2385	16 × 40	0.035	2410			
2200	16 × 35.5	0.020	2680	18 × 40	0.030	2560			
3300	18 × 40	0.017	3040						

MINIATURE TYPES

MINIATURE ALUMINUM ELECTROLYTIC CAPACITORS

MK High Ripple Current Series

IZI Low Impedance **S** Solvent Proof

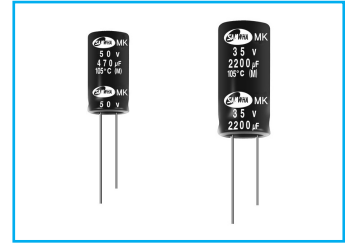

- Ripple current compared with RZ series
- Enabled high ripple current by a reduction of impedance at high frequency
- High reliability withstanding 5000 hours load life at 105°C (2000 ~ 3000 hours for smaller case sizes as specified below)
- Complied to the RoHS directive

RZ → **MK**
Miniature High Ripple

Item	Characteristics																	
Operating temperature range	-40 ~ +105°C																	
Leakage current max.	I = 0.01CV or 3µA whichever is greater (after 2 minutes) I = 0.03CV or 4µA whichever is greater (after 1 minute)																	
Capacitance tolerance	±20% at 120Hz, 20°C																	
Dissipation factor max. (at 120Hz, 20°C)	Capacitance > 1000µF : tanδ increases by 0.02 for each 1000µF from below value.																	
	<table border="1"> <thead> <tr> <th>WV</th> <th>6.3</th> <th>10</th> <th>16</th> <th>25</th> <th>35</th> <th>50</th> <th>63</th> <th>100</th> </tr> </thead> <tbody> <tr> <td>tanδ</td> <td>0.22</td> <td>0.19</td> <td>0.16</td> <td>0.14</td> <td>0.12</td> <td>0.10</td> <td>0.08</td> <td>0.08</td> </tr> </tbody> </table>	WV	6.3	10	16	25	35	50	63	100	tanδ	0.22	0.19	0.16	0.14	0.12	0.10	0.08
WV	6.3	10	16	25	35	50	63	100										
tanδ	0.22	0.19	0.16	0.14	0.12	0.10	0.08	0.08										
Low temperature characteristics (Impedance ratio at 120Hz)	Z-40°C / Z+20°C																	
	Z-25°C / Z+20°C																	
Load life	After an application of DC bias voltage plus the rated AC ripple current for 5000 hours at 105°C. The measurement shall meet the following limits. The DC voltage plus the peak AC voltage combined must not exceed the rated voltage.																	
	Leakage current	Less than specified value																
	Capacitance change	Within ±25% of the initial value																
	tanδ	Less than 200% of the specified value																
	<table border="1"> <thead> <tr> <th>∅D</th> <th>∅D = 5, 6.3</th> <th>∅D = 8</th> <th>∅D ≥ 10</th> </tr> </thead> <tbody> <tr> <td>Life time</td> <td>2000 hours</td> <td>3000 hours</td> <td>5000 hours</td> </tr> </tbody> </table>	∅D	∅D = 5, 6.3	∅D = 8	∅D ≥ 10	Life time	2000 hours	3000 hours	5000 hours									
	∅D	∅D = 5, 6.3	∅D = 8	∅D ≥ 10														
Life time	2000 hours	3000 hours	5000 hours															
Shelf life (at 105°C)	After 1000 hours no load test, leakage current, capacitance and tanδ are same as load life value. The measurement shall be performed at 20°C by the KS C IEC 60384 - 4																	

● DRAWING

Unit : mm

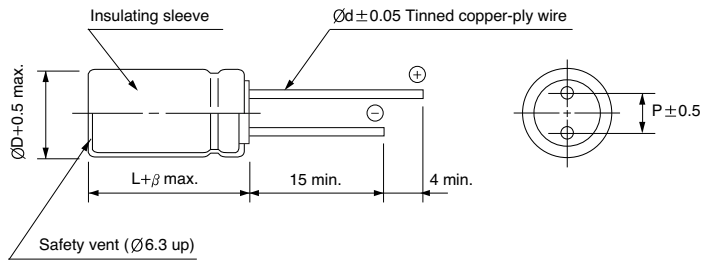

∅D	5	6.3	8	10	12.5	16	18
P	2.0	2.5	3.5	5.0	5.0	7.5	7.5
∅d	0.5	0.5	0.6	0.6	0.6	0.8	0.8
β	1.5		2.0				

● FREQUENCY COEFFICIENT OF PERMISSIBLE RIPPLE CURRENT

µF \ Frequency	120Hz	1kHz	10kHz	50kHz	100kHz ≤
~ 33	0.40	0.65	0.82	0.94	1.00
47 ~ 220	0.50	0.70	0.84	0.96	1.00
330 ~ 680	0.55	0.75	0.86	0.96	1.00
820 ~ 1800	0.60	0.80	0.88	0.97	1.00
2200 ~	0.70	0.85	0.90	0.97	1.00

MK series

● DIMENSIONS & MAXIMUM PERMISSIBLE RIPPLE CURRENT

WV Item μF	6.3			10			16			25		
	∅D×L (mm)	Impedance (Ω)max. 20°C 100kHz	Ripple current (mA rms) 105°C 100kHz	∅D×L (mm)	Impedance (Ω)max. 20°C 100kHz	Ripple current (mA rms) 105°C 100kHz	∅D×L (mm)	Impedance (Ω)max. 20°C 100kHz	Ripple current (mA rms) 105°C 100kHz	∅D×L (mm)	Impedance (Ω)max. 20°C 100kHz	Ripple current (mA rms) 105°C 100kHz
10							5 × 11	0.525	250	5 × 11	0.85	250
22	5 × 11	0.525	250	5 × 11	0.525	250	5 × 11	0.525	270	5 × 11	0.525	270
33	5 × 11	0.525	270	5 × 11	0.525	270	5 × 11	0.525	290	5 × 11	0.525	290
47	5 × 11	0.450	290	5 × 11	0.450	290	5 × 11	0.450	310	5 × 11	0.500	310
100	5 × 11	0.450	310	5 × 11	0.450	310	5 × 11	0.450	310	6.3 × 11	0.225	460
							6.3 × 11	0.300	405			
150	6.3 × 11	0.300	405	6.3 × 11	0.300	405	6.3 × 11	0.225	460	8 × 11.5	0.160	760
220	6.3 × 11	0.225	460	6.3 × 11	0.225	460	8 × 11.5	0.108	760	8 × 11.5	0.160	950
330	6.3 × 11	0.225	505	8 × 11.5	0.150	760	8 × 11.5	0.108	950	10 × 12.5	0.088	1280
390	8 × 11.5	0.108	550	8 × 11.5	0.150	760	8 × 15	0.098	1000	8 × 15	0.098	1430
							10 × 12.5	0.098	1000	10 × 12.5	0.098	1430
470	8 × 11.5	0.108	950	8 × 11.5	0.150	950	8 × 11.5	0.108	950	10 × 12.5	0.098	1430
							8 × 15	0.098	1100	10 × 16	0.065	1785
							10 × 12.5	0.088	1280	10 × 20	0.060	1785
560	8 × 15	0.098	1000	8 × 15	0.098	1100	8 × 20	0.088	1280	8 × 20	0.088	1900
	10 × 12.5	0.098	1050	10 × 12.5	0.098	1100	10 × 16	0.088	1280	10 × 16	0.088	1900
680	10 × 12.5	0.088	1280	8 × 15	0.098	1280	10 × 16	0.065	1785	10 × 16	0.065	1900
				10 × 12.5	0.088					10 × 20	0.050	2270
820	10 × 16	0.075	1300	10 × 12.5	0.088	1400	10 × 16	0.065	1785	10 × 20	0.050	2300
1000	10 × 16	0.065	1785	8 × 20	0.088	1600	8 × 20	0.088	2000	10 × 20	0.050	2400
				10 × 12.5			0.065	10 × 16				
				10 × 16	0.065	1785	10 × 20	0.050	2270			
1200				10 × 16	0.065	2200				12.5 × 20	0.043	3100
1500	10 × 20	0.050	2270	10 × 20	0.050	2270	12.5 × 20	0.043	2450	12.5 × 25	0.029	3470
				16 × 20	0.029	3600						
1800	10 × 20	0.050	2300	12.5 × 20	0.043	2350	12.5 × 25	0.029	2950	12.5 × 25	0.029	3650
				10 × 20	0.05	2650						
2200	12.5 × 20	0.043	2950	12.5 × 20	0.043	2950	12.5 × 25	0.029	3460	12.5 × 25	0.029	3700
				16 × 25	0.024	3890						
3300	12.5 × 20	0.040	3000	12.5 × 25	0.029	3140	16 × 25	0.024	3500	16 × 31.5	0.024	3900
				16 × 20								
4700	16 × 25	0.024	3114	16 × 25	0.024	3200	16 × 31.5	0.024	3600	18 × 35.5	0.022	3950
6800	16 × 25	0.024	3114	16 × 31.5	0.024	3312	18 × 35.5	0.022	3700			
10000	16 × 31.5	0.024	3312	18 × 35.5	0.022	3420						
15000	18 × 35.5	0.022	3420									

MINIATURE ALUMINUM ELECTROLYTIC CAPACITORS

MK series

● DIMENSIONS & MAXIMUM PERMISSIBLE RIPPLE CURRENT

WV Item μF	35			50			63			100			
	ØD×L (mm)	Impedance (Ω)max. 20°C 100kHz	Ripple current (mA rms) 105°C 100kHz	ØD×L (mm)	Impedance (Ω)max. 20°C 100kHz	Ripple current (mA rms) 105°C 100kHz	ØD×L (mm)	Impedance (Ω)max. 20°C 100kHz	Ripple current (mA rms) 105°C 100kHz	ØD×L (mm)	Impedance (Ω)max. 20°C 100kHz	Ripple current (mA rms) 105°C 100kHz	
1.0				5 × 11	3.00	250							
2.2				5 × 11	3.00	250				5 × 11	3.000	125	
3.3				5 × 11	1.50	250	5 × 11	2.000	165	5 × 11	2.000	125	
4.7	5 × 11	0.525	250	5 × 11	1.50	270	5 × 11	2.000	165	5 × 11	2.000	125	
10	5 × 11	0.525	270	5 × 11	0.750	290	5 × 11	0.800	165	6.3 × 11	1.200	205	
22	5 × 11	0.525	290	5 × 11	0.500	310	6.3 × 11	0.500	265	8 × 11.5	0.600	355	
33	5 × 11	0.450	310	6.3 × 11	0.300	405	6.3 × 11	0.500	265	10 × 12.5	0.250	450	
47	6.3 × 11	0.330	460	6.3 × 11	0.300	460	8 × 11.5	0.300	500	8 × 15	0.300	500	
56	6.3 × 11	0.330	460	8 × 11.5	0.160	580	10 × 12.5	0.160	680	10 × 16	0.160	750	
										10 × 20	0.150	800	
100	8 × 11.5	0.160	760	8 × 11.5	0.160	950	10 × 16	0.100	945	12.5 × 20	0.100	1045	
150	8 × 11.5	0.160	950	8 × 15	0.108	960				10 × 20	0.080	1100	12.5 × 25
	220	8 × 15	0.098	1030	10 × 16	0.065	1785	12.5 × 20	0.070	1300	16 × 25	0.060	1600
10 × 12.5		0.088	1280										
330	10 × 16	0.065	1785	10 × 20	0.050	2270	12.5 × 20	0.050	1495	16 × 31.5	0.040	1750	
390	8 × 20	0.088	1830	10 × 20	0.050	2270	12.5 × 25	0.039	1600	16 × 31.5	0.040	1750	
470	8 × 20	0.088	1930	12.5 × 20	0.043	2950	16 × 20	0.035	1990	18 × 40	0.030	2060	
	10 × 16	0.065											2270
	10 × 20	0.050											2400
680	10 × 20	0.050	2400	12.5 × 25	0.029	3460	16 × 25	0.030	2780				
	12.5 × 20	0.043	2950										
1000	12.5 × 20	0.043	3100	16 × 25	0.027	3890	16 × 35.5	0.020	2835				
	12.5 × 25	0.032	3460										
1500	12.5 × 25	0.029	3500	16 × 31.5	0.024	3900							
	16 × 20	0.027	3600										
	16 × 25	0.024	3890										
2200	16 × 31.5	0.024	3900	18 × 35.5	0.022	3950							
3300	18 × 35.5	0.022	3950										

MINIATURE ALUMINUM ELECTROLYTIC CAPACITORS



MZ Ultra Low Impedance Series

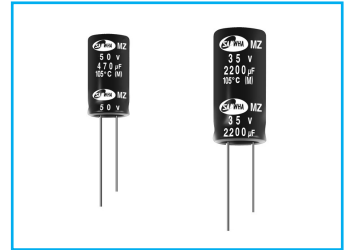

- Low impedance compared with MK series
- Enabled high ripple current by a reduction of impedance at high frequency
- High reliability withstanding 5000 hours load life at 105°C (2000~3000 hours for smaller case sizes as specified below)
- Complied to the RoHS directive

MK → MZ
Low Imp.

Item	Characteristics																	
Operating temperature range	-40 ~ +105°C																	
Leakage current max.	I = 0.01CV or 3µA whichever is greater (after 2 minutes) I = 0.03CV or 4µA whichever is greater (after 1 minute)																	
Capacitance tolerance	±20% at 120Hz, 20°C																	
Dissipation factor max. (at 120Hz, 20°C)	Capacitance > 1000µF : tanδ increases by 0.02 for each 1000µF from below value.																	
	<table border="1"> <thead> <tr> <th>WV</th> <th>6.3</th> <th>10</th> <th>16</th> <th>25</th> <th>35</th> <th>50</th> <th>63</th> <th>100</th> </tr> </thead> <tbody> <tr> <td>tanδ</td> <td>0.22</td> <td>0.19</td> <td>0.16</td> <td>0.14</td> <td>0.12</td> <td>0.10</td> <td>0.09</td> <td>0.08</td> </tr> </tbody> </table>	WV	6.3	10	16	25	35	50	63	100	tanδ	0.22	0.19	0.16	0.14	0.12	0.10	0.09
WV	6.3	10	16	25	35	50	63	100										
tanδ	0.22	0.19	0.16	0.14	0.12	0.10	0.09	0.08										
Low temperature characteristics (Impedance ratio at 120Hz)	Z-40°C / Z+20°C																	
	Z-25°C / Z+20°C																	
Load life	After an application of DC bias voltage plus the rated AC ripple current for 5000 hours at 105°C. The measurement shall meet the following limits. The DC voltage plus the peak AC voltage combined must not exceed the rated voltage.																	
	Leakage current	Less than specified value																
	Capacitance change	Within ±25% of initial value																
	tanδ	Less than 200% of specified value																
	<table border="1"> <thead> <tr> <th>∅D</th> <th>∅D = 5, 6.3</th> <th>∅D = 8</th> <th>∅D ≥ 10</th> </tr> </thead> <tbody> <tr> <td>Life time</td> <td>2000 hours</td> <td>3000 hours</td> <td>5000 hours</td> </tr> </tbody> </table>	∅D	∅D = 5, 6.3	∅D = 8	∅D ≥ 10	Life time	2000 hours	3000 hours	5000 hours									
∅D	∅D = 5, 6.3	∅D = 8	∅D ≥ 10															
Life time	2000 hours	3000 hours	5000 hours															
Shelf life (at 105°C)	After 1000 hours no load test, leakage current, capacitance and tanδ are same as load life value. The measurement shall be performed at 20°C by the KS C IEC 60384 - 4																	

DRAWING

Unit : mm

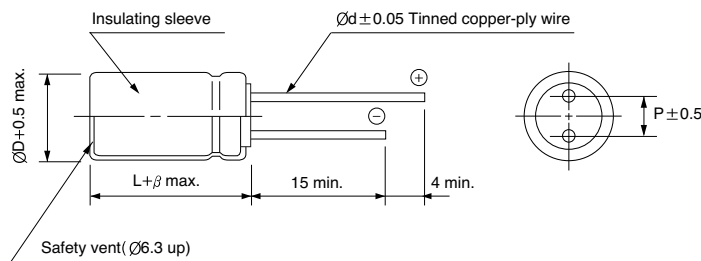

∅D	5	6.3	8	10	12.5	16	18
P	2.0	2.5	3.5	5.0	5.0	7.5	7.5
∅d	0.5	0.5	0.6	0.6	0.6	0.8	0.8
β	1.5			2.0			

FREQUENCY COEFFICIENT OF PERMISSIBLE RIPPLE CURRENT

µF \ Frequency	120Hz	1kHz	10kHz	50kHz	100kHz ≤
~ 33	0.42	0.70	0.90	0.95	1.00
47 ~ 220	0.50	0.73	0.92	0.96	1.00
330 ~ 680	0.55	0.77	0.94	0.97	1.00
1000 ~ 1500	0.60	0.80	0.96	0.98	1.00
2200 ~	0.70	0.85	0.98	0.99	1.00

MINIATURE TYPES

MINIATURE ALUMINUM ELECTROLYTIC CAPACITORS

MZ series

● DIMENSIONS & MAXIMUM PERMISSIBLE RIPPLE CURRENT

WV Item μF	6.3			10			16			25		
	$\text{ØD} \times \text{L}$ (mm)	Impedance (Ω)max. 20°C 100kHz	Ripple current (mA rms) 105°C 100kHz	$\text{ØD} \times \text{L}$ (mm)	Impedance (Ω)max. 20°C 100kHz	Ripple current (mA rms) 105°C 100kHz	$\text{ØD} \times \text{L}$ (mm)	Impedance (Ω)max. 20°C 100kHz	Ripple current (mA rms) 105°C 100kHz	$\text{ØD} \times \text{L}$ (mm)	Impedance (Ω)max. 20°C 100kHz	Ripple current (mA rms) 105°C 100kHz
10							5 × 11	0.35	250	5 × 11	0.60	250
22	5 × 11	0.35	250	5 × 11	0.35	250	5 × 11	0.35	250	5 × 11	0.40	250
33	5 × 11	0.35	250	5 × 11	0.35	250	5 × 11	0.35	250	5 × 11	0.40	250
47	5 × 11	0.30	250	5 × 11	0.30	250	5 × 11	0.30	250	5 × 11	0.30	250
100	5 × 11	0.30	250	5 × 11	0.30	250	6.3 × 11	0.15	405	6.3 × 11	0.15	405
150	6.3 × 11	0.15	405	6.3 × 11	0.15	405	6.3 × 11	0.15	405	8 × 11.5	0.10	760
220	6.3 × 11	0.15	405	6.3 × 11	0.15	405	8 × 11.5	0.085	760	8 × 11.5	0.10	760
330	6.3 × 11	0.15	405	8 × 11.5	0.12	760	8 × 11.5	0.085	760	10 × 12.5	0.08	1030
470	8 × 11.5	0.072	760	8 × 11.5	0.10	760	10 × 12.5	0.053	1030	10 × 16	0.045	1430
680	10 × 12.5	0.053	1030	10 × 12.5	0.053	1030	10 × 16	0.038	1430	10 × 20	0.032	1820
1000	10 × 12.5	0.053	1030	10 × 16	0.038	1430	10 × 20	0.027	1820	12.5 × 20	0.025	2360
1500	10 × 20	0.027	1820	10 × 20	0.032	1820	12.5 × 20	0.025	2360	16 × 20	0.020	3460
2200	12.5 × 20	0.025	2360	12.5 × 20	0.025	2360	12.5 × 25	0.018	2770	16 × 25	0.015	3460
3300	12.5 × 20	0.025	2360	12.5 × 25	0.024	2770	16 × 25	0.015	3460	16 × 31.5	0.015	3680
4700	16 × 25	0.015	3460	16 × 25	0.015	3460	16 × 31.5	0.015	3680	18 × 35.5	0.014	3800
6800	16 × 25	0.015	3460	16 × 31.5	0.015	3680	18 × 35.5	0.014	3800			
10000	16 × 31.5	0.015	3680	18 × 35.5	0.014	3800						
15000	18 × 35.5	0.014	3800									

WV Item μF	35			50			63			100		
	$\text{ØD} \times \text{L}$ (mm)	Impedance (Ω)max. 20°C 100kHz	Ripple current (mA rms) 105°C 100kHz	$\text{ØD} \times \text{L}$ (mm)	Impedance (Ω)max. 20°C 100kHz	Ripple current (mA rms) 105°C 100kHz	$\text{ØD} \times \text{L}$ (mm)	Impedance (Ω)max. 20°C 100kHz	Ripple current (mA rms) 105°C 100kHz	$\text{ØD} \times \text{L}$ (mm)	Impedance (Ω)max. 20°C 100kHz	Ripple current (mA rms) 105°C 100kHz
1.0				5 × 11	2.0	250						
2.2				5 × 11	2.0	250				5 × 11	2.0	125
3.3				5 × 11	1.0	250	5 × 11	2.0	165	5 × 11	2.0	125
4.7	5 × 11	0.35	250	5 × 11	1.0	250	5 × 11	2.0	165	5 × 11	2.0	125
10	5 × 11	0.35	250	5 × 11	0.55	250	5 × 11	0.80	165	6.3 × 11	0.50	205
22	5 × 11	0.35	250	5 × 11	0.45	250	6.3 × 11	0.50	265	8 × 11.5	0.30	355
33	5 × 11	0.30	250	6.3 × 11	0.25	405	6.3 × 11	0.50	265	10 × 12.5	0.25	450
47	6.3 × 11	0.15	405	6.3 × 11	0.20	405	8 × 11.5	0.30	500	10 × 16	0.20	580
100	8 × 11.5	0.072	760	8 × 11.5	0.105	760	10 × 16	0.10	945	12.5 × 20	0.10	1045
150	8 × 11.5	0.072	760	10 × 12.5	0.061	1030	10 × 20	0.08	1100	12.5 × 25	0.070	1195
220	10 × 12.5	0.065	1030	10 × 20	0.038	1430	12.5 × 20	0.07	1300	16 × 25	0.060	1600
330	10 × 16	0.038	1430	10 × 20	0.032	1820	12.5 × 20	0.04	1495	16 × 31.5	0.040	1750
470	10 × 20	0.027	1820	12.5 × 20	0.027	2360	16 × 20	0.035	1990	18 × 40	0.030	2060
680	12.5 × 20	0.025	2360	12.5 × 25	0.022	2770	16 × 25	0.030	2780			
1000	12.5 × 25	0.022	2770	16 × 25	0.018	3460	16 × 35.5	0.020	2835			
1500	16 × 25	0.018	3460	16 × 31.5	0.015	3680						
2200	16 × 31.5	0.015	3680	18 × 35.5	0.014	3800						
3300	18 × 35.5	0.014	3800									

MINIATURE ALUMINUM ELECTROLYTIC CAPACITORS



KN Low Imp., High Ripple Current Series

Low Impedance
 Miniaturized
 Solvent Proof

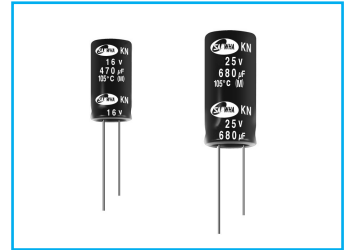

- High ripple current compared with MN series
- Enabled high ripple current by a reduction of impedance at high frequency range
- High reliability withstanding 5000 hours load life at 105°C
- Complied to the RoHS directive

Item	Characteristics											
Operating temperature range	-40 ~ +105°C											
Leakage current max.	I = 0.01CV or 3µA whichever is greater (after 2 minutes) I = 0.03CV or 4µA whichever is greater (after 1 minute)											
Capacitance tolerance	±20% at 120Hz, 20°C											
Dissipation factor max. (at 120Hz, 20°C)	Capacitance > 1000µF : tanδ increases by 0.02 for each 1000µF from below value.											
	<table border="1"> <tr> <td>WV</td> <td>10</td> <td>16</td> <td>25</td> <td>35</td> <td>50</td> </tr> <tr> <td>tanδ</td> <td>0.19</td> <td>0.16</td> <td>0.14</td> <td>0.12</td> <td>0.10</td> </tr> </table>	WV	10	16	25	35	50	tanδ	0.19	0.16	0.14	0.12
WV	10	16	25	35	50							
tanδ	0.19	0.16	0.14	0.12	0.10							
Low temperature characteristics (Impedance ratio at 120Hz)	Z-40°C / Z+20°C											
	Z-25°C / Z+20°C											
Load life	After an application of DC bias voltage plus the rated AC ripple current for 5000 hours at 105°C. The measurement shall meet the following limits. The DC voltage plus the peak AC voltage combined must not exceed the rated voltage.											
	<table border="1"> <tr> <td>Leakage current</td> <td>Less than specified value</td> </tr> <tr> <td>Capacitance change</td> <td>Within ±25% of initial value</td> </tr> <tr> <td>tanδ</td> <td>Less than 200% of specified value</td> </tr> </table>	Leakage current	Less than specified value	Capacitance change	Within ±25% of initial value	tanδ	Less than 200% of specified value					
	Leakage current	Less than specified value										
	Capacitance change	Within ±25% of initial value										
tanδ	Less than 200% of specified value											
<table border="1"> <tr> <td>Case Size</td> <td>∅D ≤ 6.3</td> <td>∅D = 8</td> <td>∅D ≥ 10</td> </tr> <tr> <td>Life time</td> <td>2000 hours</td> <td>3000 hours</td> <td>5000 hours</td> </tr> </table>	Case Size	∅D ≤ 6.3	∅D = 8	∅D ≥ 10	Life time	2000 hours	3000 hours	5000 hours				
Case Size	∅D ≤ 6.3	∅D = 8	∅D ≥ 10									
Life time	2000 hours	3000 hours	5000 hours									
Shelf life (at 105°C)	After 1000 hours no load test, leakage current, capacitance and tanδ are same as load life value. The measurement shall be performed at 20°C by the KS C IEC 60384 - 4											

DRAWING

Unit : mm

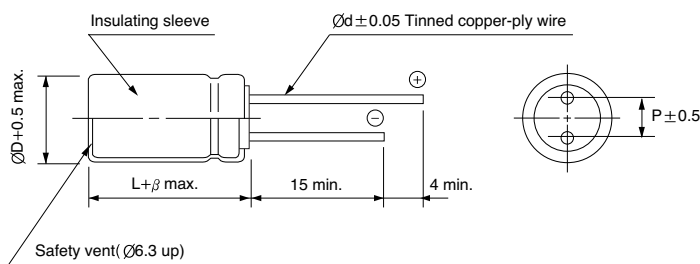

∅D	5	6.3	8	10	12.5
P	2.0	2.5	3.5	5.0	5.0
∅d	0.5	0.5	0.6	0.6	0.6
β	1.5			2.0	

FREQUENCY COEFFICIENT OF PERMISSIBLE RIPPLE CURRENT

µF	Frequency	120Hz	1kHz	10kHz	50kHz	100kHz ≤
~ 47		0.18	0.70	0.90	0.94	1.00
56 ~ 100		0.27	0.73	0.92	0.95	1.00
120 ~ 270		0.49	0.73	0.92	0.96	1.00
330 ~ 680		0.55	0.77	0.94	0.97	1.00
820 ~ 1500		0.60	0.80	0.96	0.98	1.00
2200 ~		0.70	0.85	0.98	0.99	1.00