

3

SURFACE MOUNT ALUMINUM ELECTROLYTIC CAPACITORS

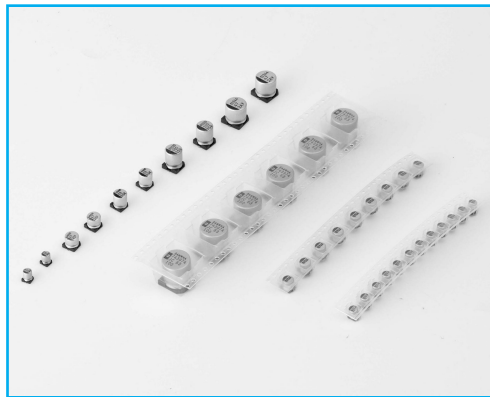

SURFACE MOUNT ALUMINUM ELECTROLYTIC CAPACITORS

● Taping Specifications for Chip Type Capacitors

● Carrier Tape

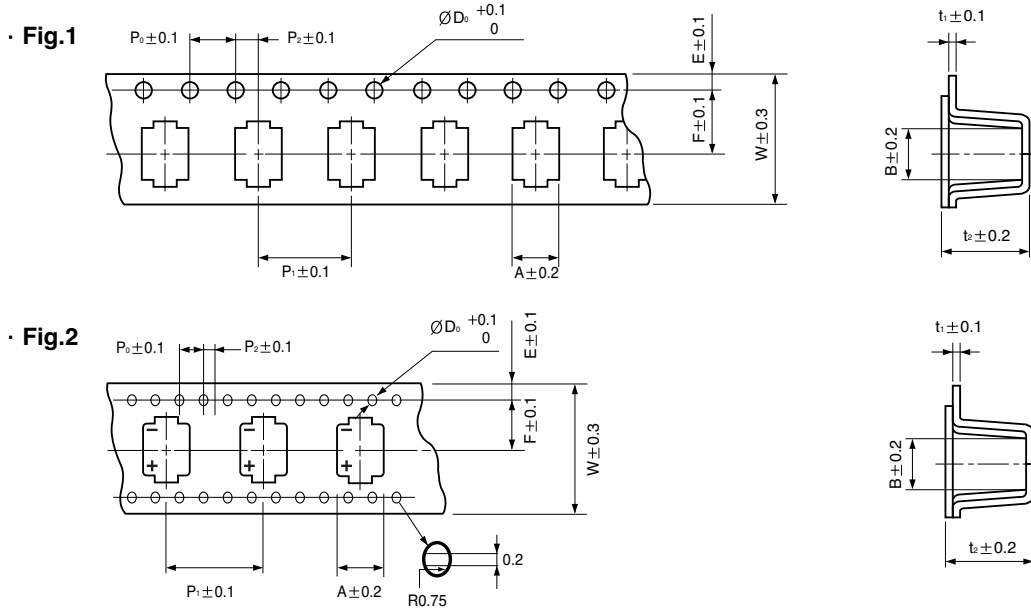

ØD×L	A	B	ØD ₀	E	F	P ₀	P ₁	P ₂	t ₁	t ₂	W	Fig.
4 × 5.3	4.7	4.7	1.5	1.75	5.5	4.0	8.0	2.0	0.4	5.7	12.0	1
5 × 5.3	5.7	5.7	1.5	1.75	5.5	4.0	12.0	2.0	0.4	5.7	12.0	
6.3 × 5.3	7.0	7.0	1.5	1.75	7.5	4.0	12.0	2.0	0.4	5.7	16.0	
6.3 × 5.8	7.0	7.0	1.5	1.75	7.5	4.0	12.0	2.0	0.4	6.3	16.0	
6.3 × 7.7	7.0	7.0	1.5	1.75	7.5	4.0	12.0	2.0	0.4	8.2	16.0	
8 × 6.2	8.7	8.7	1.5	1.75	7.5	4.0	12.0	2.0	0.4	6.8	16.0	
8 × 10	8.7	8.7	1.5	1.75	11.5	4.0	16.0	2.0	0.4	11.0	24.0	
10 × 10	10.7	10.7	1.5	1.75	11.5	4.0	16.0	2.0	0.4	11.0	24.0	
12.5 × 13.5	14.0	14.0	1.5	1.75	14.2	4.0	24.0	2.0	0.5	14.0	32.0	2

● Reel

Fig.1(PAPER)

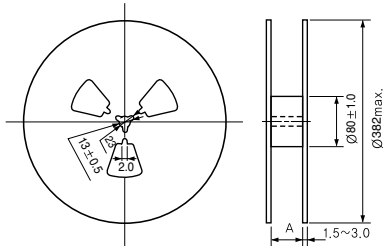
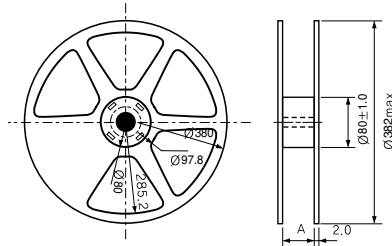
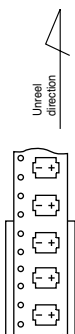

Fig.2(PLASTIC)



● Polarity



ØD×L	A	
	Fig.1	Fig.2
4 × 5.3	14	12
5 × 5.3	14	12
6.3 × 5.3	18	16
6.3 × 5.8	18	16
6.3 × 7.7	18	16
8 × 6.2	18	16
8 × 10	26	24
10 × 10	26	24
12.5 × 13.5	34	32

ØD×L	Q'ty/Reel(pcs.)	Q'ty/Box(pcs.)
4 × 5.3	2000	20000
5 × 5.3	1000	10000
6.3 × 5.3	1000	10000
6.3 × 5.8	1000	10000
6.3 × 7.7	900	9000
8 × 6.2	1000	10000
8 × 10	500	3000
10 × 10	500	3000
12.5 × 13.5	200	1000

● Recommended Land Size

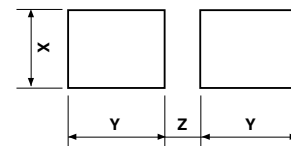

Type	ØD×L	X	Y	Z
VR	4×5.3	1.6	2.6	1.0
	5×5.3	1.6	3.0	1.4
	6.3×5.3	1.6	3.5	2.0
	6.3×5.8	1.6	3.5	2.0
	6.3×7.7	1.6	3.5	2.0
	8×6.2	2.5	4.0	2.0
	8×10	2.5	3.5	3.0
	10×10	2.5	4.0	4.0
VG	6.3×7.7	3.0	4.0	1.6
	8×10	4.3	5.3	2.0
	10×10	4.3	5.6	3.3
	12.5×13.5	7.0	7.3	3.0

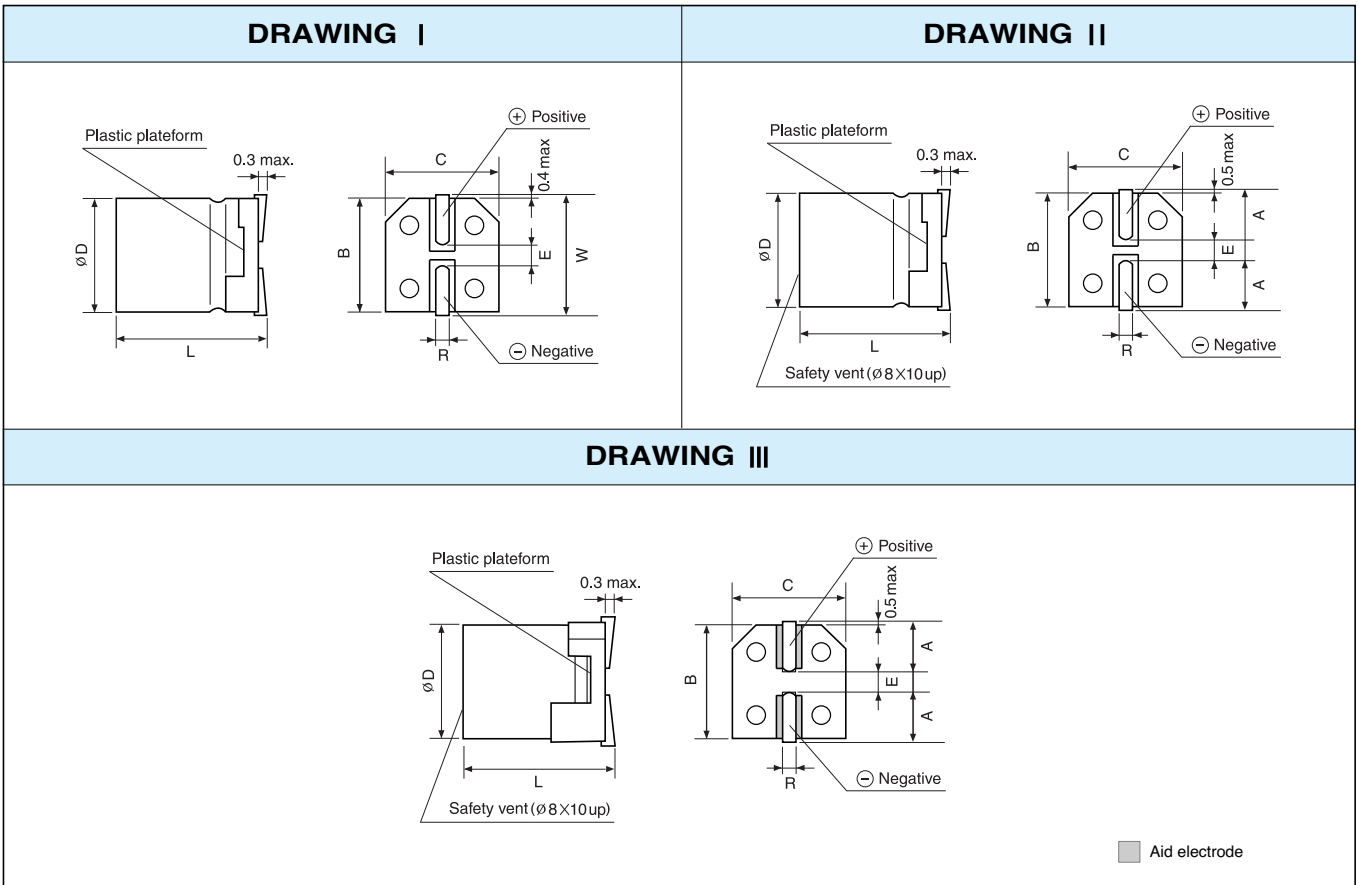

● DIMENSION OF STANDARD TYPE

APPLICABLE DRAWING NO.	Ø × D	B ± 0.2	C ± 0.2	E ± 0.2	A ± 0.2	R
DRAWING I	4 × 5.3	4.3	4.3	1.0	4.8	0.5 ~ 0.8
	5 × 5.3	5.3	5.3	1.4	5.8	0.5 ~ 0.8

APPLICABLE DRAWING NO.	Ø × D	B ± 0.2	C ± 0.2	E ± 0.2	A ± 0.2	R
DRAWING II	6.3 × 5.3	6.6	6.6	2.2	2.4	0.5 ~ 0.8
	6.3 × 5.8	6.6	6.6	2.2	2.4	0.5 ~ 0.8
	6.3 × 7.7	6.6	6.6	2.2	2.4	0.5 ~ 0.8
	8 × 6.2	8.3	8.3	2.3	3.3	0.5 ~ 0.8
	8 × 10	8.3	8.3	3.1	2.9	0.8 ~ 1.1
	10 × 10	10.3	10.3	4.5	3.2	0.8 ~ 1.1
	10 × 12.5	10.3	10.3	4.5	3.2	0.8 ~ 1.1
	12.5 × 13.5	12.8	12.8	4.5	4.6	1.3 ~ 1.6

● DIMENSION OF VIBRATION RESISTANT TYPE (FOR 30G)

APPLICABLE DRAWING NO.	Ø × D	B ± 0.2	C ± 0.2	E ± 0.2	A ± 0.2	R
DRAWING III	6.3 × 7.7	6.6	6.6	2.2	2.4	0.5 ~ 0.8
	8 × 10	8.3	8.3	3.1	2.9	0.8 ~ 1.1
	10 × 10	10.3	10.3	4.5	3.2	0.8 ~ 1.1
	12.5 × 13.5	12.8	12.8	4.5	4.6	1.3 ~ 1.6

SURFACE MOUNT ALUMINUM ELECTROLYTIC CAPACITORS

SC Chip type, Standard Series

S
Solvent Proof
WV ≤ 100V

- Chip type higher capacitance in larger case sizes
- Designed for surface mounting on high density PC board
- Applicable to automatic insertion machine using carrier tape
- Complied to the RoHS directive
- AEC-Q200 compliant : Please contact us for more details.

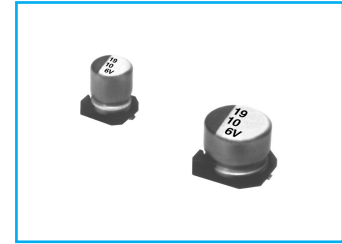

Item	Characteristics
Operating temperature range	-40 ~ +85°C
Leakage current max.	WV ≤ 100 I = 0.01CV or 3μA whichever is greater (after 2 minutes) WV ≥ 160 I = 0.04CV + 100μA(after 1 minutes)
Capacitance tolerance	±20% at 120Hz, 20°C
Dissipation factor max. (at 120Hz, 20°C)	WV 4 6.3 10 16 25 35 50 63 100 160 200 250 400 450
	tanδ 0.40 0.35 0.24 0.20 0.16 0.13 0.12 0.12 0.12 0.20 0.20 0.20 0.25 0.25
Low temperature characteristics (Impedance ratio at 120Hz)	WV 4 6.3 10 16 25 35 ~ 100 160 ~ 250 400 ~ 450
	Z-25°C/Z+20°C 6 5 4 3 2 2 3 6
	Z-40°C/Z+20°C 12 10 8 6 4 3 6 10
Load life (after application of the rated voltage for 2000 hours at 85°C)	Leakage current Less than specified value
	Capacitance change Within ±20% of initial value (Small size : ±25%)
	tanδ Less than 200% of the specified value
Shelf life(at 85°C)	After 1000 hours no load test, leakage current, capacitance and tanδ are same as load life value. The measurement shall be performed at 20°C by the KS C IEC 60384 - 4
Resistance to soldering heat	Leakage current Less than specified value
	Capacitance change Within ±10% of initial value
	tanδ Less than specified value

● DRAWING -Series code of SC is "V"

Unit : mm

(Ø4, Ø5)

(Ø6.3, Ø8×6.2)

(Ø8×10, Ø10×10)

ØD×L	W	A	B	C	E	R
4×5.3	4.8		4.3	4.3	1.0	0.5~0.8
5×5.3	5.8		5.3	5.3	1.4	0.5~0.8
6.3×5.3		2.4	6.6	6.6	2.2	0.5~0.8
6.3×5.8		2.4	6.6	6.6	2.2	0.5~0.8
6.3×7.7		2.4	6.6	6.6	2.2	0.5~0.8
8×6.2		3.3	8.3	8.3	2.3	0.5~0.8
8×10		2.9	8.3	8.3	3.1	0.8~1.1
10×10		3.2	10.3	10.3	4.5	0.8~1.1
12.5×13.5		4.6	12.8	12.8	4.5	1.3~1.6

SC series

● DIMENSIONS & MAXIMUM PERMISSIBLE RIPPLE CURRENT

μF \diagdown WV	4		6.3		10		16		25		35		50																																																																																																																																																																																																																																																																																																																												
1.0													4×5.3	10																																																																																																																																																																																																																																																																																																																											
2.2											4×5.3	11	4×5.3	15																																																																																																																																																																																																																																																																																																																											
3.3									4×5.3	15	4×5.3	16	4×5.3	18																																																																																																																																																																																																																																																																																																																											
4.7							4×5.3	16	4×5.3	18	4×5.3	19	4×5.3	24														5×5.3	25	10	4×5.3	16	4×5.3	19	4×5.3	21	4×5.3	21	4×5.3	24	4×5.3	27	5×5.3	41										5×5.3	30	5×5.3	32	6.3×5.3	43	22	4×5.3	24	4×5.3	29	4×5.3	28	4×5.3	30	5×5.3	41	6.3×5.3	55	6.3×5.3	71						5×5.3	36	5×5.3	41	6.3×5.3	53			6.3×5.8	73	33	4×5.3	29	4×5.3	30	4×5.3	34	5×5.3	43	5×5.3	50	6.3×5.3	65	6.3×7.7	94				5×5.3	41	5×5.3	44	6.3×5.3	58	6.3×5.3	64	6.3×5.8	67	8×6.2	95	47	4×5.3	35	4×5.3	36	5×5.3	47	5×5.3	52	6.3×5.3	70	6.3×7.7	94	6.3×7.7	105				5×5.3	48	6.3×5.3	62	6.3×5.3	69	6.3×5.8	72	8×6.2	105	8×10	140	100	5×5.3	54	5×5.3	60	6.3×5.3	80	6.3×5.3	88	8×6.2	145	6.3×7.7	132	8×10	181		6.3×5.3	68	6.3×5.3	82	6.3×5.8	82	6.3×5.8	91			8×10	175	10×10	195	220	6.3×5.3	93	6.3×5.8	91	6.3×7.7	173	6.3×7.7	162	8×10	232	10×10	265	10×10	320				8×6.2	175	8×10	215			10×10	250					330			6.3×7.7	188	8×10	240	8×10	270	10×10	305	10×10	360	12.5×13.5	600				8×6.2	190											470			8×10	265	8×10	290	8×10	307	10×10	400	12.5×13.5	600										10×10	330							1000			8×10	370	10×10	454	12.5×13.5	710	12.5×13.5	820								10×10	400											1500			10×10	480	12.5×13.5	850	12.5×13.5	870							2200			12.5×13.5	890	12.5×13.5	960								
													5×5.3	25																																																																																																																																																																																																																																																																																																																											
10	4×5.3	16	4×5.3	19	4×5.3	21	4×5.3	21	4×5.3	24	4×5.3	27	5×5.3	41										5×5.3	30	5×5.3	32	6.3×5.3	43	22	4×5.3	24	4×5.3	29	4×5.3	28	4×5.3	30	5×5.3	41	6.3×5.3	55	6.3×5.3	71						5×5.3	36	5×5.3	41	6.3×5.3	53			6.3×5.8	73	33	4×5.3	29	4×5.3	30	4×5.3	34	5×5.3	43	5×5.3	50	6.3×5.3	65	6.3×7.7	94				5×5.3	41	5×5.3	44	6.3×5.3	58	6.3×5.3	64	6.3×5.8	67	8×6.2	95	47	4×5.3	35	4×5.3	36	5×5.3	47	5×5.3	52	6.3×5.3	70	6.3×7.7	94	6.3×7.7	105				5×5.3	48	6.3×5.3	62	6.3×5.3	69	6.3×5.8	72	8×6.2	105	8×10	140	100	5×5.3	54	5×5.3	60	6.3×5.3	80	6.3×5.3	88	8×6.2	145	6.3×7.7	132	8×10	181		6.3×5.3	68	6.3×5.3	82	6.3×5.8	82	6.3×5.8	91			8×10	175	10×10	195	220	6.3×5.3	93	6.3×5.8	91	6.3×7.7	173	6.3×7.7	162	8×10	232	10×10	265	10×10	320				8×6.2	175	8×10	215			10×10	250					330			6.3×7.7	188	8×10	240	8×10	270	10×10	305	10×10	360	12.5×13.5	600				8×6.2	190											470			8×10	265	8×10	290	8×10	307	10×10	400	12.5×13.5	600										10×10	330							1000			8×10	370	10×10	454	12.5×13.5	710	12.5×13.5	820								10×10	400											1500			10×10	480	12.5×13.5	850	12.5×13.5	870							2200			12.5×13.5	890	12.5×13.5	960																																						
									5×5.3	30	5×5.3	32	6.3×5.3	43																																																																																																																																																																																																																																																																																																																											
22	4×5.3	24	4×5.3	29	4×5.3	28	4×5.3	30	5×5.3	41	6.3×5.3	55	6.3×5.3	71						5×5.3	36	5×5.3	41	6.3×5.3	53			6.3×5.8	73	33	4×5.3	29	4×5.3	30	4×5.3	34	5×5.3	43	5×5.3	50	6.3×5.3	65	6.3×7.7	94				5×5.3	41	5×5.3	44	6.3×5.3	58	6.3×5.3	64	6.3×5.8	67	8×6.2	95	47	4×5.3	35	4×5.3	36	5×5.3	47	5×5.3	52	6.3×5.3	70	6.3×7.7	94	6.3×7.7	105				5×5.3	48	6.3×5.3	62	6.3×5.3	69	6.3×5.8	72	8×6.2	105	8×10	140	100	5×5.3	54	5×5.3	60	6.3×5.3	80	6.3×5.3	88	8×6.2	145	6.3×7.7	132	8×10	181		6.3×5.3	68	6.3×5.3	82	6.3×5.8	82	6.3×5.8	91			8×10	175	10×10	195	220	6.3×5.3	93	6.3×5.8	91	6.3×7.7	173	6.3×7.7	162	8×10	232	10×10	265	10×10	320				8×6.2	175	8×10	215			10×10	250					330			6.3×7.7	188	8×10	240	8×10	270	10×10	305	10×10	360	12.5×13.5	600				8×6.2	190											470			8×10	265	8×10	290	8×10	307	10×10	400	12.5×13.5	600										10×10	330							1000			8×10	370	10×10	454	12.5×13.5	710	12.5×13.5	820								10×10	400											1500			10×10	480	12.5×13.5	850	12.5×13.5	870							2200			12.5×13.5	890	12.5×13.5	960																																																																				
					5×5.3	36	5×5.3	41	6.3×5.3	53			6.3×5.8	73																																																																																																																																																																																																																																																																																																																											
33	4×5.3	29	4×5.3	30	4×5.3	34	5×5.3	43	5×5.3	50	6.3×5.3	65	6.3×7.7	94				5×5.3	41	5×5.3	44	6.3×5.3	58	6.3×5.3	64	6.3×5.8	67	8×6.2	95	47	4×5.3	35	4×5.3	36	5×5.3	47	5×5.3	52	6.3×5.3	70	6.3×7.7	94	6.3×7.7	105				5×5.3	48	6.3×5.3	62	6.3×5.3	69	6.3×5.8	72	8×6.2	105	8×10	140	100	5×5.3	54	5×5.3	60	6.3×5.3	80	6.3×5.3	88	8×6.2	145	6.3×7.7	132	8×10	181		6.3×5.3	68	6.3×5.3	82	6.3×5.8	82	6.3×5.8	91			8×10	175	10×10	195	220	6.3×5.3	93	6.3×5.8	91	6.3×7.7	173	6.3×7.7	162	8×10	232	10×10	265	10×10	320				8×6.2	175	8×10	215			10×10	250					330			6.3×7.7	188	8×10	240	8×10	270	10×10	305	10×10	360	12.5×13.5	600				8×6.2	190											470			8×10	265	8×10	290	8×10	307	10×10	400	12.5×13.5	600										10×10	330							1000			8×10	370	10×10	454	12.5×13.5	710	12.5×13.5	820								10×10	400											1500			10×10	480	12.5×13.5	850	12.5×13.5	870							2200			12.5×13.5	890	12.5×13.5	960																																																																																																		
			5×5.3	41	5×5.3	44	6.3×5.3	58	6.3×5.3	64	6.3×5.8	67	8×6.2	95																																																																																																																																																																																																																																																																																																																											
47	4×5.3	35	4×5.3	36	5×5.3	47	5×5.3	52	6.3×5.3	70	6.3×7.7	94	6.3×7.7	105				5×5.3	48	6.3×5.3	62	6.3×5.3	69	6.3×5.8	72	8×6.2	105	8×10	140	100	5×5.3	54	5×5.3	60	6.3×5.3	80	6.3×5.3	88	8×6.2	145	6.3×7.7	132	8×10	181		6.3×5.3	68	6.3×5.3	82	6.3×5.8	82	6.3×5.8	91			8×10	175	10×10	195	220	6.3×5.3	93	6.3×5.8	91	6.3×7.7	173	6.3×7.7	162	8×10	232	10×10	265	10×10	320				8×6.2	175	8×10	215			10×10	250					330			6.3×7.7	188	8×10	240	8×10	270	10×10	305	10×10	360	12.5×13.5	600				8×6.2	190											470			8×10	265	8×10	290	8×10	307	10×10	400	12.5×13.5	600										10×10	330							1000			8×10	370	10×10	454	12.5×13.5	710	12.5×13.5	820								10×10	400											1500			10×10	480	12.5×13.5	850	12.5×13.5	870							2200			12.5×13.5	890	12.5×13.5	960																																																																																																																																
			5×5.3	48	6.3×5.3	62	6.3×5.3	69	6.3×5.8	72	8×6.2	105	8×10	140																																																																																																																																																																																																																																																																																																																											
100	5×5.3	54	5×5.3	60	6.3×5.3	80	6.3×5.3	88	8×6.2	145	6.3×7.7	132	8×10	181		6.3×5.3	68	6.3×5.3	82	6.3×5.8	82	6.3×5.8	91			8×10	175	10×10	195	220	6.3×5.3	93	6.3×5.8	91	6.3×7.7	173	6.3×7.7	162	8×10	232	10×10	265	10×10	320				8×6.2	175	8×10	215			10×10	250					330			6.3×7.7	188	8×10	240	8×10	270	10×10	305	10×10	360	12.5×13.5	600				8×6.2	190											470			8×10	265	8×10	290	8×10	307	10×10	400	12.5×13.5	600										10×10	330							1000			8×10	370	10×10	454	12.5×13.5	710	12.5×13.5	820								10×10	400											1500			10×10	480	12.5×13.5	850	12.5×13.5	870							2200			12.5×13.5	890	12.5×13.5	960																																																																																																																																																														
	6.3×5.3	68	6.3×5.3	82	6.3×5.8	82	6.3×5.8	91			8×10	175	10×10	195																																																																																																																																																																																																																																																																																																																											
220	6.3×5.3	93	6.3×5.8	91	6.3×7.7	173	6.3×7.7	162	8×10	232	10×10	265	10×10	320				8×6.2	175	8×10	215			10×10	250					330			6.3×7.7	188	8×10	240	8×10	270	10×10	305	10×10	360	12.5×13.5	600				8×6.2	190											470			8×10	265	8×10	290	8×10	307	10×10	400	12.5×13.5	600										10×10	330							1000			8×10	370	10×10	454	12.5×13.5	710	12.5×13.5	820								10×10	400											1500			10×10	480	12.5×13.5	850	12.5×13.5	870							2200			12.5×13.5	890	12.5×13.5	960																																																																																																																																																																																												
			8×6.2	175	8×10	215			10×10	250																																																																																																																																																																																																																																																																																																																															
330			6.3×7.7	188	8×10	240	8×10	270	10×10	305	10×10	360	12.5×13.5	600				8×6.2	190											470			8×10	265	8×10	290	8×10	307	10×10	400	12.5×13.5	600										10×10	330							1000			8×10	370	10×10	454	12.5×13.5	710	12.5×13.5	820								10×10	400											1500			10×10	480	12.5×13.5	850	12.5×13.5	870							2200			12.5×13.5	890	12.5×13.5	960																																																																																																																																																																																																																										
			8×6.2	190																																																																																																																																																																																																																																																																																																																																					
470			8×10	265	8×10	290	8×10	307	10×10	400	12.5×13.5	600										10×10	330							1000			8×10	370	10×10	454	12.5×13.5	710	12.5×13.5	820								10×10	400											1500			10×10	480	12.5×13.5	850	12.5×13.5	870							2200			12.5×13.5	890	12.5×13.5	960																																																																																																																																																																																																																																																								
							10×10	330																																																																																																																																																																																																																																																																																																																																	
1000			8×10	370	10×10	454	12.5×13.5	710	12.5×13.5	820								10×10	400											1500			10×10	480	12.5×13.5	850	12.5×13.5	870							2200			12.5×13.5	890	12.5×13.5	960																																																																																																																																																																																																																																																																																						
			10×10	400																																																																																																																																																																																																																																																																																																																																					
1500			10×10	480	12.5×13.5	850	12.5×13.5	870																																																																																																																																																																																																																																																																																																																																	
2200			12.5×13.5	890	12.5×13.5	960																																																																																																																																																																																																																																																																																																																																			

↑ ↑
 ———— Ripple current (mA rms) at 85°C, 120Hz
 ———— Case size $\varnothing D \times L$ (mm)

μF \diagdown WV	63		100		160		200		250		400		450																																																																																																																									
2.2													10×10	85																																																																																																																								
3.3			6.3×5.8	29							10×10	90	10×10	100																																																																																																																								
4.7	6.3×5.8	31	6.3×5.8	35			10×10	100	10×10	100	12.5×13.5	115	12.5×13.5	115				8×6.2	40											10	6.3×5.8	46	8×10	77	10×10	100	12.5×13.5	150	12.5×13.5	150					22	8×6.2	96	8×10	100	12.5×13.5	240	12.5×13.5	260							33	8×10	117	10×10	130	12.5×13.5	260									47	10×10	140	10×10	155											68	10×10	160	12.5×13.5	350											100	12.5×13.5	370	12.5×13.5	420											220	12.5×13.5	550												
			8×6.2	40																																																																																																																																		
10	6.3×5.8	46	8×10	77	10×10	100	12.5×13.5	150	12.5×13.5	150																																																																																																																												
22	8×6.2	96	8×10	100	12.5×13.5	240	12.5×13.5	260																																																																																																																														
33	8×10	117	10×10	130	12.5×13.5	260																																																																																																																																
47	10×10	140	10×10	155																																																																																																																																		
68	10×10	160	12.5×13.5	350																																																																																																																																		
100	12.5×13.5	370	12.5×13.5	420																																																																																																																																		
220	12.5×13.5	550																																																																																																																																				

↑ ↑
 ———— Ripple current (mA rms) at 85°C, 120Hz
 ———— Case size $\varnothing D \times L$ (mm)

● FREQUENCY COEFFICIENT OF PERMISSIBLE RIPPLE CURRENT

Frequency	50Hz	120Hz	300Hz	1kHz	10kHz \leq
Coefficient	0.70	1.00	1.17	1.36	1.50

CHIP TYPES

SURFACE MOUNT ALUMINUM ELECTROLYTIC CAPACITORS

RC Chip type, Wide Temperature Range Series



- Wide operating temperature range of -55 ~ +105°C
- Designed for surface mounting on high density PC board
- Applicable to automatic insertion machine using carrier tape
- Complied to the RoHS directive
- AEC-Q200 compliant : Please contact us for more details.



Item	Characteristics	
Operating temperature range	-55 ~ +105°C	
Leakage current max.	I = 0.01CV or 3μA whichever is greater (after 2 minutes)	
Capacitance tolerance	±20% at 120Hz, 20°C	
Dissipation factor max. (at 120Hz, 20°C)	WV	6.3 10 16 25 35 50
	tanδ	0.27 0.23 0.19 0.15 0.13 0.11
Low temperature characteristics (Impedance ratio at 120Hz)	WV	6.3 10 16 25 35 50
	Z-25°C/Z+20°C	3 3 2 2 2 2
	Z-55°C/Z+20°C	8 5 4 3 3 3
Load life (after application of the rated voltage for 1000 hours at 105°C)	Leakage current	Less than specified value
	Capacitance change	Within ±25% of initial value
	tanδ	Less than 200% of specified value
Shelf life (at 105°C)	After 1000 hours no load test, leakage current, capacitance and tanδ are same as load life value. The measurement shall be performed at 20°C by the KS C IEC 60384 - 4	
Resistance to soldering heat	The following specifications shall be satisfied when the capacitors are restored to 20°C after exposing them at 250°C for 10 seconds.	
	Leakage current	Less than specified value
	Capacitance change	Within ±10% of initial value
	tanδ	Less than specified value

● DRAWING (See page 58)

-Series code of RC is "F"

● DIMENSIONS & MAXIMUM PERMISSIBLE RIPPLE CURRENT

μF \ WV	6.3		10		16		25		35		50	
1.0											4×5.3	7
2.2											4×5.3	11
3.3											4×5.3	13
4.7							4×5.3	13	4×5.3	14	5×5.3	18
10					4×5.3	17	5×5.3	23	5×5.3	24	6.3×5.3	31
22	4×5.3	22	5×5.3	27	5×5.3	30	6.3×5.3	39	6.3×5.3	42	6.3×5.8	45
33	5×5.3	31	5×5.3	33	6.3×5.3	43	6.3×5.3	48	6.3×5.8	52	6.3×7.7	60
47	5×5.3	36	6.3×5.3	46	6.3×5.3	51	6.3×5.8	59	6.3×5.8	63	6.3×7.7	63
100	6.3×5.3	50	6.3×5.8	64	6.3×5.8	64	6.3×7.7	91	8×10	296	10×10	295
220	6.3×7.7	86	6.3×7.7	105	6.3×7.7	105	8×10	340	10×10	435		
330	6.3×7.7	105	8×10	305	8×10	340	10×10	360				
470	8×10	330	10×10	340	10×10	470						
1000	10×10	475										

↑ ↑ Ripple current (mA rms) at 105°C, 120Hz
Case size ØD×L (mm)

● FREQUENCY COEFFICIENT OF PERMISSIBLE RIPPLE CURRENT

Frequency	50Hz	120Hz	300Hz	1kHz	10kHz ≤
Coefficient	0.70	1.00	1.17	1.36	1.50

SURFACE MOUNT ALUMINUM ELECTROLYTIC CAPACITORS



JH Chip type, High Ripple Current Series

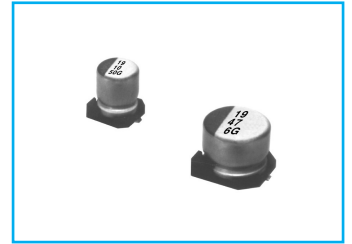

- High Ripple current Compared with JC series
- Designed for surface mounting on high density PC board
- Applicable to automatic insertion machine using carrier tape
- Complied to the RoHS directive
- AEC-Q200 compliant : Please contact us for more details.



Item	Characteristics																																
Operating temperature range	WV ≤ 100 : -55 ~ +105°C WV ≥ 160 : -40 ~ +105°C																																
Leakage current max.	WV ≤ 100 I = 0.01CV or 3μA whichever is greater (after 2 minutes) WV ≥ 160 I = 0.04CV + 100μA(after 1 minutes)																																
Capacitance tolerance	±20% at 120Hz, 20°C																																
Dissipation factor max. (at 120Hz, 20°C)	<table border="1"> <tr> <td>WV</td> <td>6.3</td> <td>10</td> <td>16</td> <td>25</td> <td>35</td> <td>50</td> <td>63</td> <td>100</td> <td>160</td> <td>200</td> <td>250</td> <td>400</td> </tr> <tr> <td>tanδ</td> <td>0.28</td> <td>0.24</td> <td>0.20</td> <td>0.16</td> <td>0.13</td> <td>0.12</td> <td>0.10</td> <td>0.10</td> <td>0.15</td> <td>0.15</td> <td>0.15</td> <td>0.20</td> </tr> </table>	WV	6.3	10	16	25	35	50	63	100	160	200	250	400	tanδ	0.28	0.24	0.20	0.16	0.13	0.12	0.10	0.10	0.15	0.15	0.15	0.20						
WV	6.3	10	16	25	35	50	63	100	160	200	250	400																					
tanδ	0.28	0.24	0.20	0.16	0.13	0.12	0.10	0.10	0.15	0.15	0.15	0.20																					
Low temperature characteristics (Impedance ratio at 120Hz)	<table border="1"> <tr> <td>WV</td> <td>6.3</td> <td>10</td> <td>16</td> <td>25 ~ 50</td> <td>63 ~ 100</td> <td>160 ~ 250</td> <td>400</td> </tr> <tr> <td>Z-25°C/Z+20°C</td> <td>3</td> <td>3</td> <td>2</td> <td>2</td> <td>3</td> <td>3</td> <td>6</td> </tr> <tr> <td>Z-40°C/Z+20°C</td> <td>-</td> <td>-</td> <td>-</td> <td>-</td> <td>-</td> <td>6</td> <td>10</td> </tr> <tr> <td>Z-55°C/Z+20°C</td> <td>8</td> <td>5</td> <td>4</td> <td>3</td> <td>4</td> <td>-</td> <td>-</td> </tr> </table>	WV	6.3	10	16	25 ~ 50	63 ~ 100	160 ~ 250	400	Z-25°C/Z+20°C	3	3	2	2	3	3	6	Z-40°C/Z+20°C	-	-	-	-	-	6	10	Z-55°C/Z+20°C	8	5	4	3	4	-	-
WV	6.3	10	16	25 ~ 50	63 ~ 100	160 ~ 250	400																										
Z-25°C/Z+20°C	3	3	2	2	3	3	6																										
Z-40°C/Z+20°C	-	-	-	-	-	6	10																										
Z-55°C/Z+20°C	8	5	4	3	4	-	-																										
Load life (after application of the rated voltage for 2000 hours at 105°C)	<table border="1"> <tr> <td>Leakage current</td> <td>Less than specified value</td> </tr> <tr> <td>Capacitance change</td> <td>Within ±20% of initial value</td> </tr> <tr> <td>tanδ</td> <td>Less than 200% of specified value</td> </tr> </table>	Leakage current	Less than specified value	Capacitance change	Within ±20% of initial value	tanδ	Less than 200% of specified value																										
Leakage current	Less than specified value																																
Capacitance change	Within ±20% of initial value																																
tanδ	Less than 200% of specified value																																
Shelf life (at 105°C)	After 1000 hours no load test, leakage current, capacitance and tanδ are same as load life value. The measurement shall be performed at 20°C by the KS C IEC 60384 - 4																																
Resistance to soldering heat	<p>The following specifications shall be satisfied when the capacitors are restored to 20°C after exposing them at 250°C for 10 seconds.</p> <table border="1"> <tr> <td>Leakage current</td> <td>Less than specified value</td> </tr> <tr> <td>Capacitance change</td> <td>Within ±10% of initial value</td> </tr> <tr> <td>tanδ</td> <td>Less than specified value</td> </tr> </table>	Leakage current	Less than specified value	Capacitance change	Within ±10% of initial value	tanδ	Less than specified value																										
Leakage current	Less than specified value																																
Capacitance change	Within ±10% of initial value																																
tanδ	Less than specified value																																

● DRAWING -Series code of JH is "G"

Unit : mm

(Ø6.3, Ø8×6.2)

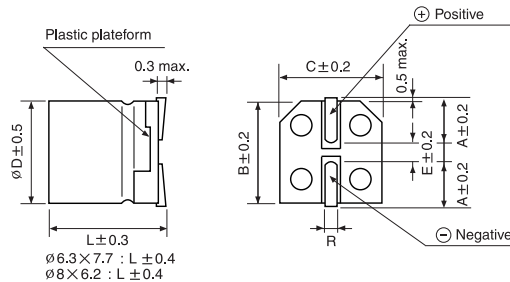
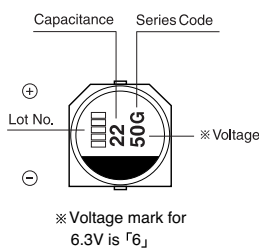

ØD×L	A	B	C	E	R
6.3×5.8	2.4	6.6	6.6	2.2	0.5~0.8
6.3×7.7	2.4	6.6	6.6	2.2	0.5~0.8
8×6.2	3.3	8.3	8.3	2.3	0.5~0.8
8×10	2.9	8.3	8.3	3.1	0.8~1.1
10×10	3.2	10.3	10.3	4.5	0.8~1.1
12.5×13.5	4.6	12.8	12.8	4.5	1.3~1.6

(Ø8×10, Ø10×10)

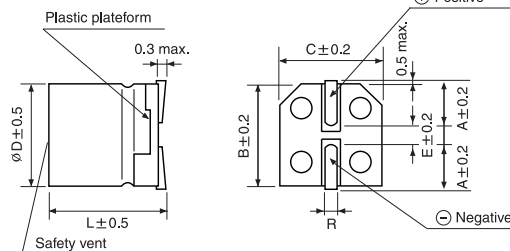
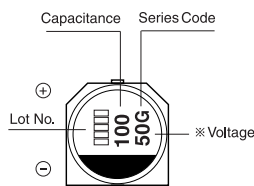

(Ø12.5)

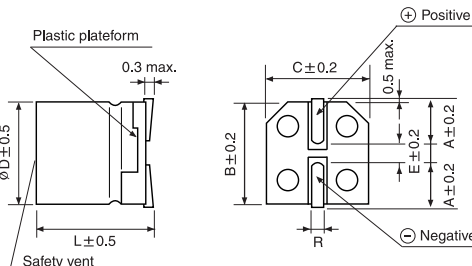
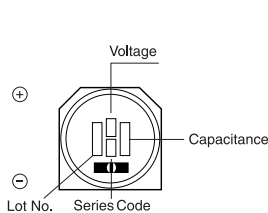

SURFACE MOUNT ALUMINUM ELECTROLYTIC CAPACITORS

JH series

● DIMENSIONS & MAXIMUM PERMISSIBLE RIPPLE CURRENT

μF \diagdown WV	6.3		10		16		25		35	
22							6.3×5.8	57	6.3×5.8	63
33					6.3×5.8	60	6.3×5.8	72	8×6.2	114
47			6.3×5.8	69	6.3×5.8	75	8×6.2	120	8×10	186
100	6.3×5.8	90	6.3×5.8	90	6.3×5.8	110	8×10	270	10×10	456
					8×10	222				
220	8×10	242	8×10	260	10×10	495	10×10	525	10×10	675
330	8×10	432	10×10	477	10×10	660	10×10	558	12.5×13.5	750
470	10×10	510	10×10	527	10×10	735	10×10	675	12.5×13.5	900
680	10×10	612	10×10	588	12.5×13.5	750	12.5×13.5	750		
1000	10×10	743	10×10	825	12.5×13.5	900				
1500	10×10	840	12.5×13.5	975						
2200	12.5×13.5	1095								

μF \diagdown WV	50		63		100	
10	6.3×5.8	45	8×6.2	48		
22	8×6.2	100	8×10	90	8×10	135
33	8×10	200	8×10	165	10×10	180
			10×10	175		
47	10×10	270	10×10	195	10×10	285
					12.5×13.5	375
68	10×10	315	10×10	240	12.5×13.5	450
100	10×10	465	12.5×13.5	405		
220	12.5×13.5	720				

μF \diagdown WV	160		200		250		400	
3.3					10×10	45	12.5×13.5	45
4.7			10×10	65	12.5×13.5	95		
10	10×10	65	12.5×13.5	110				
22	12.5×13.5	125	12.5×13.5	125				
33	12.5×13.5	140						

↑ Ripple current (mA rms) at 105°C, 120Hz
 ↑ Case size $\varnothing D \times L$ (mm)

● FREQUENCY COEFFICIENT OF PERMISSIBLE RIPPLE CURRENT

Frequency	50Hz	120Hz	300Hz	1kHz	10kHz \leq
Coefficient	0.70	1.00	1.17	1.36	1.50

SURFACE MOUNT ALUMINUM ELECTROLYTIC CAPACITORS



JM Chip type, Long Life Series

- Long Life Compared with JC series
- Designed for surface mounting on high density PC board
- Applicable to automatic insertion machine using carrier tape
- Complied to the RoHS directive
- AEC-Q200 compliant : Please contact us for more details.



Solvent Proof
WV ≤ 100V



Item	Characteristics																										
Operating temperature range	-40 ~ +105°C																										
Leakage current max.	WV ≤ 100 I = 0.01CV or 3μA whichever is greater (after 2 minutes) WV ≥ 160 I = 0.04CV + 100μA(after 1 minutes)																										
Capacitance tolerance	±20% at 120Hz, 20°C																										
Dissipation factor max. (at 120Hz, 20°C)	<table border="1"> <tr> <td>WV</td> <td>6.3</td> <td>10</td> <td>16</td> <td>25</td> <td>35</td> <td>50</td> <td>63</td> <td>100</td> <td>160</td> <td>200</td> <td>250</td> <td>400</td> </tr> <tr> <td>tanδ</td> <td>0.32</td> <td>0.28</td> <td>0.21</td> <td>0.21</td> <td>0.18</td> <td>0.18</td> <td>0.12</td> <td>0.12</td> <td>0.15</td> <td>0.15</td> <td>0.15</td> <td>0.20</td> </tr> </table>	WV	6.3	10	16	25	35	50	63	100	160	200	250	400	tanδ	0.32	0.28	0.21	0.21	0.18	0.18	0.12	0.12	0.15	0.15	0.15	0.20
WV	6.3	10	16	25	35	50	63	100	160	200	250	400															
tanδ	0.32	0.28	0.21	0.21	0.18	0.18	0.12	0.12	0.15	0.15	0.15	0.20															
Low temperature characteristics (Impedance ratio at 120Hz)	<table border="1"> <tr> <td>WV</td> <td>6.3</td> <td>10</td> <td>16</td> <td>25 ~ 50</td> <td>63 ~ 100</td> <td>160 ~ 250</td> <td>400</td> </tr> <tr> <td>Z-25°C/Z+20°C</td> <td>3</td> <td>3</td> <td>3</td> <td>3</td> <td>3</td> <td>3</td> <td>6</td> </tr> <tr> <td>Z-40°C/Z+20°C</td> <td>8</td> <td>5</td> <td>4</td> <td>3</td> <td>4</td> <td>6</td> <td>10</td> </tr> </table>	WV	6.3	10	16	25 ~ 50	63 ~ 100	160 ~ 250	400	Z-25°C/Z+20°C	3	3	3	3	3	3	6	Z-40°C/Z+20°C	8	5	4	3	4	6	10		
WV	6.3	10	16	25 ~ 50	63 ~ 100	160 ~ 250	400																				
Z-25°C/Z+20°C	3	3	3	3	3	3	6																				
Z-40°C/Z+20°C	8	5	4	3	4	6	10																				
Load life (after application of the rated voltage for 3000 hours at 105°C)	<table border="1"> <tr> <td>Leakage current</td> <td>Less than specified value</td> </tr> <tr> <td>Capacitance change</td> <td>Within ±30% of initial value</td> </tr> <tr> <td>tanδ</td> <td>Less than 300% of specified value</td> </tr> </table>	Leakage current	Less than specified value	Capacitance change	Within ±30% of initial value	tanδ	Less than 300% of specified value																				
Leakage current	Less than specified value																										
Capacitance change	Within ±30% of initial value																										
tanδ	Less than 300% of specified value																										
Shelf life (at 105°C)	After 1000 hours no load test, leakage current, capacitance and tanδ are same as load life value. The measurement shall be performed at 20°C by the KS C IEC 60384 - 4																										
Resistance to soldering heat	The following specifications shall be satisfied when the capacitors are restored to 20°C after exposing them at 250°C for 10 seconds. <table border="1"> <tr> <td>Leakage current</td> <td>Less than specified value</td> </tr> <tr> <td>Capacitance change</td> <td>Within ±10% of initial value</td> </tr> <tr> <td>tanδ</td> <td>Less than specified value</td> </tr> </table>	Leakage current	Less than specified value	Capacitance change	Within ±10% of initial value	tanδ	Less than specified value																				
Leakage current	Less than specified value																										
Capacitance change	Within ±10% of initial value																										
tanδ	Less than specified value																										

● DRAWING -Series code of JM is "Q"

Unit : mm

(Ø4, Ø5)

※ Voltage mark for 6.3V is '6_J'

ØD×L	W	A	B	C	E	R
4×5.3	4.8		4.3	4.3	1.0	0.5~0.8
5×5.3	5.8		5.3	5.3	1.4	0.5~0.8
6.3×5.3		2.4	6.6	6.6	2.2	0.5~0.8
6.3×5.8		2.4	6.6	6.6	2.2	0.5~0.8
6.3×7.7		2.4	6.6	6.6	2.2	0.5~0.8
8×6.2		3.3	8.3	8.3	2.3	0.5~0.8
8×10		2.9	8.3	8.3	3.1	0.8~1.1
10×10		3.2	10.3	10.3	4.5	0.8~1.1
12.5×13.5		4.6	12.8	12.8	4.5	1.3~1.6

(Ø6.3, Ø8×6.2)

※ Voltage mark for 6.3V is '6_J'

(Ø12.5)

(Ø8×10, Ø10×10)

※ Voltage mark for 6.3V is '6_J'

CHIP TYPES

SURFACE MOUNT ALUMINUM ELECTROLYTIC CAPACITORS

JM series

● DIMENSIONS & MAXIMUM PERMISSIBLE RIPPLE CURRENT

μF \diagdown WV	6.3		10		16		25		35	
10	4×5.3	10	4×5.3	15	4×5.3	19	5×5.3	24	6.3×5.3	26
22	4×5.3	25	5×5.3	30	5×5.3	33	6.3×5.3	38	6.3×5.8	42
33	5×5.3	35	5×5.3	38	6.3×5.3	42	6.3×5.8	48	8×6.2	76
47	5×5.3	42	6.3×5.3	52	6.3×5.8	60	8×6.2	79	8×10	124
100	6.3×5.8	60	6.3×5.8	60	8×10	148	8×10	181	10×10	310
220	8×10	161	8×10	173	10×10	330	10×10	351	10×10	480
330	8×10	288	10×10	318	10×10	441	10×10	372	12.5×13.5	500
470	10×10	340	10×10	351	10×10	489	10×10	450	12.5×13.5	600
680	10×10	408	10×10	392	12.5×13.5	500	12.5×13.5	500		
1000	10×10	495	10×10	550	12.5×13.5	600				
1500	10×10	560	12.5×13.5	650						
2200	12.5×13.5	730								

μF \diagdown WV	50		63		100	
10	6.3×5.8	30	8×6.2	32		
22	8×6.2	67	8×10	60	8×10	90
33	8×10	133	8×10	110	10×10	120
47	10×10	180	10×10	130	12.5×13.5	250
68	10×10	200	10×10	160	12.5×13.5	300
100	10×10	310	12.5×13.5	270		
220	12.5×13.5	480				

μF \diagdown WV	160		200		250		400	
2.2							8×10	27
3.3					10×10	30	12.5×13.5	30
4.7			10×10	45	12.5×13.5	65	12.5×13.5	40
6.8								
10	10×10	45	12.5×13.5	75				
22	12.5×13.5	85	12.5×13.5	85				
33	12.5×13.5	95						

↑
Ripple current (mA rms) at 105°C, 120Hz
↑
Case size $\varnothing D \times L$ (mm)

● FREQUENCY COEFFICIENT OF PERMISSIBLE RIPPLE CURRENT

Frequency	50Hz	120Hz	300Hz	1kHz	10kHz \leq
Coefficient	0.70	1.00	1.17	1.36	1.50

CA Chip type, Long Life Series

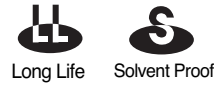

- Chip type, long life capacitance in large case sizes
- Chip type with load life of 5000 hours at 105°C
- Designed for surface mounting on high density PC board
- Applicable to automatic insertion machine using carrier tape
- Complied to the RoHS directive
- AEC-Q200 compliant : Please contact us for more details.

Item	Characteristics						
Operating temperature range	$\varnothing D \leq 6.3$			$\varnothing D \geq 8$			
	-40 ~ +105°C			-55 ~ +105°C			
Leakage current max.	I = 0.01CV or 3 μ A whichever is greater (after 2 minutes)						
Capacitance tolerance	$\pm 20\%$ at 120Hz, 20°C						
Dissipation factor max. (at 120Hz, 20°C)	WV	6.3	10	16	25	35	50
	tan δ	0.28	0.24	0.2	0.16	0.13	0.12
Low temperature characteristics (Impedance ratio at 120Hz)	WV	6.3	10	16	25	35	50
	Z-25°C/Z+20°C	2	2	2	3	3	3
	Z-55°C/Z+20°C	14	12	8	6	4	4
	Z-40°C/Z+20°C	14	12	8	6	4	4
Load life (after application of the rated voltage for 5000 hours at 105°C)	Leakage current	Less than specified value					
	Capacitance change	Within $\pm 30\%$ of initial value					
	tan δ	Less than 300% of specified value					
Shelf life (at 105°C)	After 1000 hours no load test, leakage current, capacitance and tan δ are same as load life value. The measurement shall be performed at 20°C by the KS C IEC 60384 - 4						
Resistance to soldering heat	The following specifications shall be satisfied when the capacitors are restored to 20°C after exposing them at 250°C for 10 seconds.						
	Leakage current	Less than specified value					
	Capacitance change	Within $\pm 10\%$ of initial value					
	tan δ	Less than specified value					

● DRAWING (See page 58)

-Series code of CA is "A"

● DIMENSIONS & MAXIMUM PERMISSIBLE RIPPLE CURRENT

μ F \ WV	6.3		10		16		25		35		50	
10											6.3×5.8	30
22							6.3×5.8	38	6.3×5.8	42	6.3×7.7	120
33					6.3×5.8	40	6.3×5.8	48	6.3×7.7	57	8×10	140
47			6.3×5.8	46	6.3×5.8	50	6.3×7.7	63	8×10	92	8×10	170
100	6.3×5.8	60	6.3×7.7	81	6.3×7.7	81	8×10	116	10×10	151	10×10	310
220	6.3×7.7	101	8×10	141	10×10	216	10×10	216	10×10	216		
330	8×10	160	10×10	238	10×10	238	10×10	238				
470	10×10	254	10×10	254	10×10	254						
1000	10×10	313										

← Ripple current (mA rms) at 105°C, 120Hz
 Case size $\varnothing D \times L$ (mm)

● FREQUENCY COEFFICIENT OF PERMISSIBLE RIPPLE CURRENT

Frequency	50Hz	120Hz	300Hz	1kHz	10kHz \leq
Coefficient	0.70	1.00	1.17	1.36	1.50

SURFACE MOUNT ALUMINUM ELECTROLYTIC CAPACITORS

CB Chip type, Long Life Series

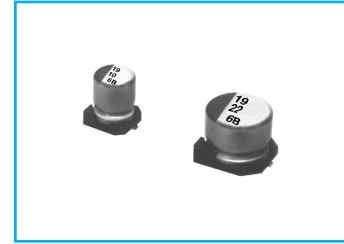

- Chip type with load life 5000 hours at 105°C
- Chip type with 5.5mmL Height
- Designed for surface mounting on high density PC board
- Applicable to automatic insertion machine using carrier tape
- Complied to the RoHS directive
- AEC-Q200 compliant : Please contact us for more details.



Item	Characteristics																					
Operating temperature range	-40 ~ +105°C																					
Leakage current max.	I = 0.01CV or 3μA whichever is greater (after 2 minutes)																					
Capacitance tolerance	±20% at 120Hz, 20°C																					
Dissipation factor max. (at 120Hz, 20°C)	<table border="1"> <tr> <td>WV</td> <td>4</td> <td>6.3</td> <td>10</td> <td>16</td> <td>25</td> <td>35</td> <td>50</td> </tr> <tr> <td>tanδ</td> <td>0.32</td> <td>0.28</td> <td>0.24</td> <td>0.2</td> <td>0.16</td> <td>0.13</td> <td>0.12</td> </tr> </table>	WV	4	6.3	10	16	25	35	50	tanδ	0.32	0.28	0.24	0.2	0.16	0.13	0.12					
WV	4	6.3	10	16	25	35	50															
tanδ	0.32	0.28	0.24	0.2	0.16	0.13	0.12															
Low temperature characteristics (Impedance ratio at 120Hz)	<table border="1"> <tr> <td>WV</td> <td>4</td> <td>6.3</td> <td>10</td> <td>16</td> <td>25</td> <td>35~50</td> </tr> <tr> <td>Z-25°C/Z+20°C</td> <td>12</td> <td>10</td> <td>8</td> <td>6</td> <td>4</td> <td>4</td> </tr> <tr> <td>Z-40°C/Z+20°C</td> <td>16</td> <td>14</td> <td>12</td> <td>8</td> <td>6</td> <td>4</td> </tr> </table>	WV	4	6.3	10	16	25	35~50	Z-25°C/Z+20°C	12	10	8	6	4	4	Z-40°C/Z+20°C	16	14	12	8	6	4
WV	4	6.3	10	16	25	35~50																
Z-25°C/Z+20°C	12	10	8	6	4	4																
Z-40°C/Z+20°C	16	14	12	8	6	4																
Load life (after application of the rated voltage for 5000 hours at 105°C)	<table border="1"> <tr> <td>Capacitance change</td> <td>Within ±30% of initial value</td> </tr> <tr> <td>tanδ</td> <td>Less than 300% of the specified value</td> </tr> <tr> <td>Leakage current</td> <td>Less than specified value</td> </tr> </table>	Capacitance change	Within ±30% of initial value	tanδ	Less than 300% of the specified value	Leakage current	Less than specified value															
Capacitance change	Within ±30% of initial value																					
tanδ	Less than 300% of the specified value																					
Leakage current	Less than specified value																					
Shelf life (at 105°C)	After 1000 hours no load test, leakage current, capacitance and tanδ are same as load life value. The measurement shall be performed at 20°C by the KS C IEC 60384 - 4																					
Resistance to soldering heat	The following specifications shall be satisfied when the capacitors are restored to 20°C after exposing them at 250°C for 10 seconds. <table border="1"> <tr> <td>Leakage current</td> <td>Less than specified value</td> </tr> <tr> <td>Capacitance change</td> <td>Within ±10% of initial value</td> </tr> <tr> <td>tanδ</td> <td>Less than specified value</td> </tr> </table>	Leakage current	Less than specified value	Capacitance change	Within ±10% of initial value	tanδ	Less than specified value															
Leakage current	Less than specified value																					
Capacitance change	Within ±10% of initial value																					
tanδ	Less than specified value																					

● DRAWING (See page 58)

-Series code of CB is "B"

● DIMENSIONS & MAXIMUM PERMISSIBLE RIPPLE CURRENT

μF \ WV	4	6.3	10	16	25	35	50
1.0							4×5.3 7
2.2							4×5.3 11
3.3							4×5.3 14
4.7					4×5.3 14	4×5.3 15	5×5.3 19
6.8					4×5.3 17	5×5.3 21	6.3×5.3 26
10				4×5.3 19	5×5.3 24	5×5.3 26	6.3×5.3 33
15			4×5.3 22	5×5.3 30	5×5.3 31	6.3×5.3 37	6.3×5.3 40
22	4×5.3 24	4×5.3 25	5×5.3 30	5×5.3 33	6.3×5.3 42	6.3×5.3 45	
33	5×5.3 33	5×5.3 35	5×5.3 38	6.3×5.3 48			
47	5×5.3 40	5×5.3 42	6.3×5.3 52	6.3×5.3 57			
68	5×5.3 48	6.3×5.3 55	6.3×5.3 63				
100	5×5.3 55	6.3×5.3 67	6.3×5.3 72				

↑ Ripple current (mA rms) at 105°C, 120Hz
Case size ØD×L(mm)

● FREQUENCY COEFFICIENT OF PERMISSIBLE RIPPLE CURRENT

Frequency	50Hz	120Hz	300Hz	1kHz	10kHz ≤
Coefficient	0.70	1.00	1.17	1.36	1.50

SURFACE MOUNT ALUMINUM ELECTROLYTIC CAPACITORS



JL Chip type, Long Life Series

- Chip type, long life capacitance in large case sizes
- For ECU
- Application to automatic insertion machine using carrier tape
- Complied to the RoHS directive
- AEC-Q200 compliant : Please contact us for more details.

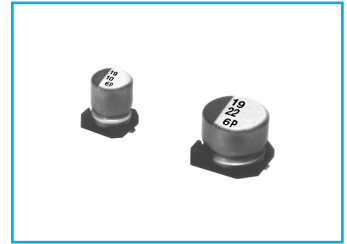
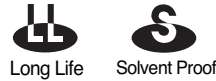

Item	Characteristics					
Operating temperature range	-40 ~ +105°C					
Leakage current	I = 0.03CV or 4μA whichever is greater (after 2 minutes)					
Capacitance tolerance	±20% (20°C, 120Hz)					
Dissipation factor max. (at 120Hz, 20°C)	Rated Voltage(V)	10	16	25	35	50
	tanδ	0.32	0.24	0.21	0.18	0.18
Low temperature characteristics (Impedance ratio at 120Hz)	WV	10	16	25	35	50
	Z-25°C/Z+20°C	6	4	3	2	2
	Z-40°C/Z+20°C	12	10	8	6	6
Load life (after application of the rated voltage for 10000 hours at 105°C)	Leakage current	Less than specified value				
	Capacitance change	Within ±30% of the initial value				
	tanδ	Less than 300% of the specified value				
Shelf life (at 105°C)	After 1000 hours no load test, leakage current, capacitance and tanδ are same as load life value. The measurement shall be performed at 20°C by the KS C IEC 60384 - 4					
Resistance to soldering heat	The following specifications shall be satisfied when the capacitors are restored to 20°C after exposing them at 250°C for 10 seconds.					
	Leakage current	Less than specified value				
	Capacitance change	Within ±10% of the initial value				
	tanδ	Less than specified value				

● DRAWING (See page 58)

-Series code of JL is "P"

● DIMENSIONS & MAXIMUM PERMISSIBLE RIPPLE CURRENT

μF \ WV	10		16		25		35		50	
33									8×10	75
47							8×10	90	8×10	90
100			8×10	270	8×10	163	10×10	132	10×10	167
220	8×10	270	8×10	270	10×10	200	10×10	249		
330	8×10	270	10×10	315	10×10	304				
470	10×10	315	10×10	315						

↑ ↑
 ——— Ripple current (mA rms) at 105°C, 120Hz
 ——— Case size ØD×L(mm)

● FREQUENCY COEFFICIENT OF PERMISSIBLE RIPPLE CURRENT

Frequency	50Hz	120Hz	300Hz	1kHz	10kHz ≤
Coefficient	0.70	1.00	1.17	1.36	1.50

SURFACE MOUNT ALUMINUM ELECTROLYTIC CAPACITORS

ZC Height 5.5mmL, Low Impedance Series

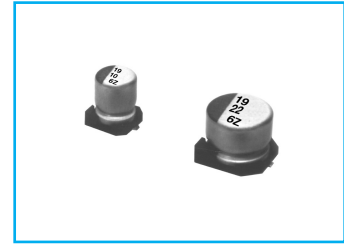

- Chip type, low impedance temperature range up to 105°C
- Designed for surface mounting on high density PC board
- Applicable to automatic insertion machine using carrier tape
- Complied to the RoHS directive
- AEC-Q200 compliant : Please contact us for more details.

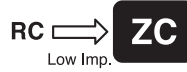

Item	Characteristics					
Operating temperature range	-55 ~ +105°C					
Leakage current max.	I = 0.01CV or 3μA whichever is greater (after 2 minutes)					
Capacitance tolerance	±20% at 120Hz, 20°C					
Dissipation factor max. (at 120Hz, 20°C)	WV	6.3	10	16	25	35
	tanδ	0.22	0.19	0.16	0.14	0.12
Low temperature characteristics (Impedance ratio at 120Hz)	WV	6.3	10	16	25	35
	Z-25°C/Z+20°C	2	2	2	2	3
	Z-55°C/Z+20°C	4	4	3	3	3
Load life (after application of the rated voltage for 1000 hours at 105°C)	Leakage current	Less than specified value				
	Capacitance change	Within ±20% of initial value				
	tanδ	Less than 200% of specified value				
Shelf life (at 105°C)	After 1000 hours no load test, leakage current, capacitance and tanδ are same as load life value. The measurement shall be performed at 20°C by the KS C IEC 60384 - 4					
Resistance to soldering heat	The following specifications shall be satisfied when the capacitors are restored to 20°C after exposing them at 250°C for 10 seconds.					
	Leakage current	Less than specified value				
	Capacitance change	Within ±10% of initial value				
	tanδ	Less than specified value				

● DRAWING (See page 58)

-Series code of ZC is "Z"

● DIMENSIONS & MAXIMUM PERMISSIBLE RIPPLE CURRENT

μF	WV	6.3			10			16			25			35		
	1.0														4×5.3	5.0
1.5														4×5.3	5.0	50
2.2														4×5.3	5.0	50
3.3														4×5.3	5.0	50
4.7											4×5.3	5.0	50	4×5.3	5.0	50
6.8											4×5.3	5.0	50	5×5.3	2.6	80
10								4×5.3	5.0	50	5×5.3	2.6	80	5×5.3	2.6	80
15								5×5.3	2.6	80	6.3×5.3	1.3	75	6.3×5.3	1.3	115
22	4×5.3	5.0	50	5×5.3	2.6	80	5×5.3	2.6	80	6.3×5.3	1.3	75	6.3×5.3	1.3	115	
33	5×5.3	2.6	80	5×5.3	2.6	80	6.3×5.3	1.3	115	6.3×5.3	1.3	115				
47	5×5.3	2.6	80	6.3×5.3	1.3	115	6.3×5.3	1.3	115	← Ripple current (mA rms) at 105°C, 100kHz						
68	6.3×5.3	1.3	115	6.3×5.3	1.3	115				↑ Impedance (Ω) at 20°C, 100kHz						
100	6.3×5.3	1.3	115							↑ Case size ØD×L(mm)						

● FREQUENCY COEFFICIENT OF PERMISSIBLE RIPPLE CURRENT

Frequency	50Hz	120Hz	300Hz	1kHz	10kHz ≤
Coefficient	0.35	0.5	0.64	0.83	1.00

SURFACE MOUNT ALUMINUM ELECTROLYTIC CAPACITORS



CD Chip type, Extremely Low Impedance Series

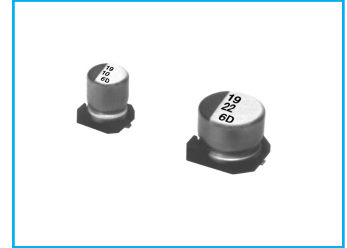

- Chip type, low impedance temperature range up to 105°C
- Designed for surface mounting on high density PC board
- Applicable to automatic insertion machine using carrier tape
- Complied to the RoHS directive
- AEC-Q200 compliant : Please contact us for more details.



Item	Characteristics									
Operating temperature range	-55 ~ +105°C									
Leakage current max.	I = 0.01CV or 3μA whichever is greater (after 2 minutes)									
Capacitance tolerance	±20% at 120Hz, 20°C									
Dissipation factor max. (at 120Hz, 20°C)	WV	6.3	10	16	25	35	50	63	80	100
	tanδ	0.24	0.19	0.16	0.14	0.12	0.12	0.10	0.10	0.10
Low temperature characteristics (Impedance ratio at 120Hz)	WV	6.3	10	16	25	35	50	63~100		
	Z-25°C/Z+20°C	2	2	2	2	2	2	3		
	Z-55°C/Z+20°C	3	3	3	3	3	3	4		
Load life (after application of the rated voltage for 2000 hours at 105°C)	Leakage current	Less than specified value								
	Capacitance change	Within ±25% of initial value								
	tanδ	Less than 200% of specified value								
Shelf life (at 105°C)	After 1000 hours no load test, leakage current, capacitance and tanδ are same as load life value. The measurement shall be performed at 20°C by the KS C IEC 60384 - 4									
Resistance to soldering heat	The following specifications shall be satisfied when the capacitors are restored to 20°C after exposing them at 250°C for 10 seconds.									
	Leakage current	Less than specified value								
	Capacitance change	Within ±10% of initial value								
	tanδ	Less than specified value								

DRAWING

Unit : mm

-Series code of CD is "D"

(∅6.3×5.8, 7.7, ∅8×6.2)

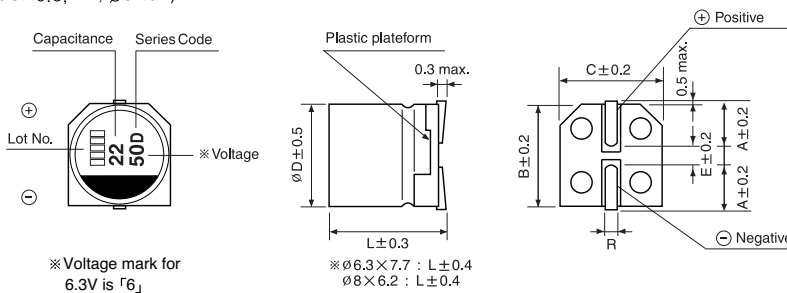

∅D	A	B	C	E	R
6.3×5.8	2.4	6.6	6.6	2.2	0.5~0.8
6.3×7.7	2.4	6.6	6.6	2.2	0.5~0.8
8×6.2	3.3	8.3	8.3	2.3	0.5~0.8
8×10	2.9	8.3	8.3	3.1	0.8~1.1
10×10	3.2	10.3	10.3	4.5	0.8~1.1
12.5×13.5	4.6	12.8	12.8	4.5	1.3~1.6

(∅8×10, ∅10×10)

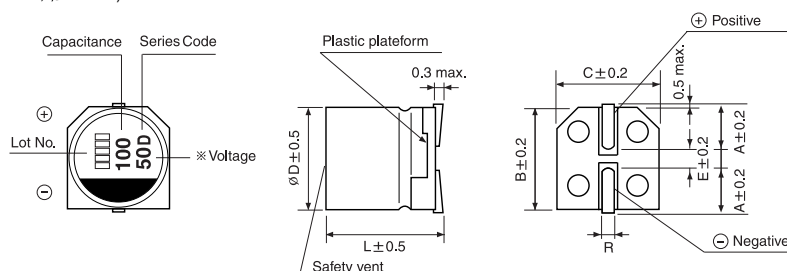

SURFACE MOUNT ALUMINUM ELECTROLYTIC CAPACITORS

CD series

● DIMENSIONS & MAXIMUM PERMISSIBLE RIPPLE CURRENT

μF \diagdown WV	6.3			10			16			25			35			50		
10																6.3×5.8	0.92	170
15																6.3×5.8	0.79	170
22																6.3×5.8	0.79	170
33							6.3×5.8	0.39	384	6.3×5.8	0.39	384	6.3×5.8	0.43	384	6.3×7.7	0.61	280
																8×6.2	0.58	300
47				6.3×5.8	0.36	384	5×5.3	1.00	210	6.3×5.8	0.39	384	6.3×5.3	0.70	240	6.3×7.7	0.61	280
							6.3×5.8	0.39	384	6.3×5.8	0.39	384	6.3×5.8	0.43	384	8×6.2	0.58	300
68	6.3×5.8	0.40	384	6.3×5.8	0.36	384	6.3×5.8	0.36	384	6.3×5.8	0.36	384	6.3×7.7	0.29	600	8×10	0.29	450
100	6.3×5.3	0.53	250	6.3×5.8	0.36	384	6.3×5.3	0.70	250	6.3×7.7	0.29	600	6.3×7.7	0.29	600	8×10	0.29	450
	6.3×5.8	0.40	384				6.3×5.8	0.36	384	8×6.2	0.24	500	8×10	0.15	960	10×10	0.18	700
150	6.3×5.8	0.40	384	6.3×5.8	0.36	384	6.3×5.8	0.36	384	8×10	0.15	960	8×10	0.15	960	10×10	0.18	700
							6.3×7.7	0.29	600									
220	6.3×5.8	0.40	384	6.3×7.7	0.32	600	6.3×7.7	0.29	600	6.3×7.7	0.29	600	8×10	0.15	960	10×10	0.18	700
				8×6.2	0.24	500	8×6.2	0.24	500	8×10	0.15	960	10×10	0.09	1360			
330	6.3×7.7	0.29	600	8×10	0.15	960	8×10	0.15	960	8×10	0.15	960	8×10	0.10	960	10×10	0.16	850
	8×6.2	0.24	500				10×10	0.10	960	10×10	0.09	1360	10×10	0.09	1360			
470	8×10	0.15	960	6.3×7.7	0.16	600	8×10	0.16	960	8×10	0.15	960	10×10	0.09	1360			
				8×10	0.15	960	10×10	0.07	1360	10×10	0.09	1360						
560	8×10	0.15	960	8×10	0.15	960	10×10	0.07	1360	10×10	0.09	1360	10×10	0.06	1360			
680	8×10	0.15	960	8×10	0.15	960	10×10	0.08	1360	10×10	0.09	1360	10×10	0.06	1360			
				10×10	0.07	1360												
820	8×10	0.15	960	10×10	0.08	1360				10×10	0.09	1360						
1000	8×10	0.15	960	10×10	0.08	1360				12.5×13.5	0.09	1360						
	10×10	0.07	1360															
1500	10×10	0.07	1360															

μF \diagdown WV	63			80			100		
10	6.3×5.8	2.30	80	6.3×7.7	2.16	60			
22	6.3×7.7	1.90	120	8×10	1.17	130	8×10	1.80	130
33	8×10	0.80	250	8×10	1.17	130	10×10	1.35	200
47	8×10	0.80	250	10×10	1.08	200	12.5×13.5	0.90	500
68	10×10	0.70	400	12.5×13.5	0.70	500	12.5×13.5	0.90	500
100	10×10	0.70	400	12.5×13.5	0.70	500			
150	12.5×13.5	0.54	800	12.5×13.5	0.70	500			
220	12.5×13.5	0.54	800						

— Ripple current (mA rms) at 105°C, 100kHz
 — Impedance (Ω) at 20°C, 100kHz
 — Case size $\varnothing D \times L$ (mm)

● FREQUENCY COEFFICIENT OF PERMISSIBLE RIPPLE CURRENT

Frequency	50Hz	120Hz	300Hz	1kHz	10kHz \leq
Coefficient	0.35	0.50	0.64	0.83	1.00

CG Chip type, Miniaturization Series



- Chip type, miniaturized temperature range up to 105°C
- Applicable to automatic insertion machine using carrier tape
- Complied to the RoHS directive
- AEC-Q200 compliant : Please contact us for more details.

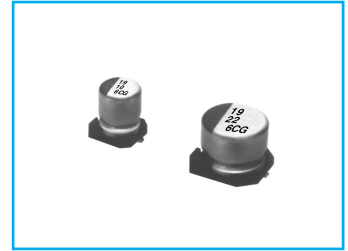

Item	Characteristics						
Operating temperature range	-55 ~ +105°C						
Leakage current max.	I = 0.01CV or 3 μ A whichever is greater (after 2 minutes)						
Capacitance tolerance	\pm 20% at 120Hz, 20°C						
Dissipation factor max. (at 120Hz, 20°C)	WV	6.3	10	16	25	35 ~ 50	63 ~ 80
	tan δ	0.24	0.19	0.16	0.14	0.12	0.08
Low temperature characteristics (Impedance ratio at 120Hz)	WV	6.3	10	16	25	35 ~ 50	63 ~ 80
	Z-25°C/Z+20°C	2	2	2	2	2	2
	Z-55°C/Z+20°C	3	3	3	3	3	3
Load life (after application of the rated voltage for 2000 hours at 105°C)	Leakage current	Less than specified value					
	Capacitance change	Within \pm 25% of initial value					
	tan δ	Less than 200% of specified value (63~80V : 300%)					
Shelf life (at 105°C)	After 1000 hours no load test, leakage current, capacitance and tan δ are same as load life value. The measurement shall be performed at 20°C by the KS C IEC 60384 - 4						
Resistance to soldering heat	The following specifications shall be satisfied when the capacitors are restored to 20°C after exposing them at 250°C for 10 seconds.						
	Leakage current	Less than specified value					
	Capacitance change	Within \pm 10% of initial value					
	tan δ	Less than specified value					

DRAWING

Unit : mm

-Series code of CG is "CG"

(\varnothing 6.3, \varnothing 6 \times 6.2)

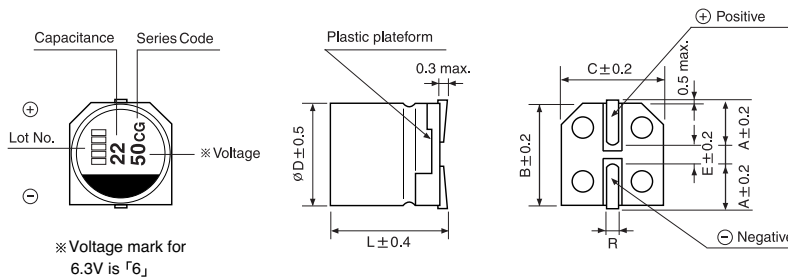

\varnothing D	A	B	C	E	R
6.3 \times 7.7	2.4	6.6	6.6	2.2	0.5~0.8
8 \times 10	2.9	8.3	8.3	3.1	0.8~1.1
10 \times 10	3.2	10.3	10.3	4.5	0.8~1.1

(\varnothing 8 \times 10, \varnothing 10 \times 10)

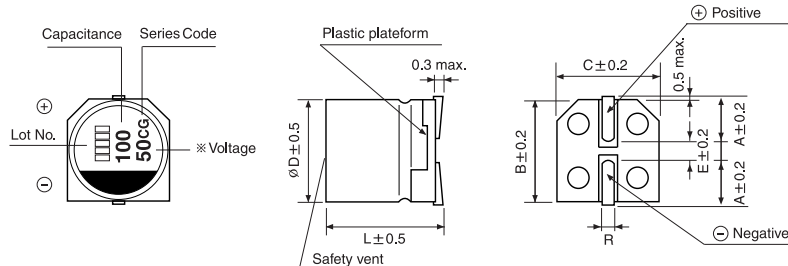

SURFACE MOUNT ALUMINUM ELECTROLYTIC CAPACITORS

CG series

● DIMENSIONS & MAXIMUM PERMISSIBLE RIPPLE CURRENT

μF \diagdown WV	6.3			10			16			25			35			50		
100																6.3×7.7	0.34	350
150										6.3×7.7	0.16	600	6.3×7.7	0.16	600			
220										6.3×7.7	0.16	600				8×10	0.18	670
330				6.3×7.7	0.16	600	6.3×7.7	0.16	600				8×10	0.08	850	10×10	0.12	900
470	6.3×7.7	0.16	600	6.3×7.7	0.16	600				8×10	0.08	850						
560													10×10	0.06	1190			
680	6.3×7.7	0.16	600				8×10	0.08	850				10×10	0.06	1190			
820										10×10	0.06	1190						
1000				8×10	0.08	850	10×10	0.06	1190									
1500	8×10	0.08	850	10×10	0.06	1190												
2200	10×10	0.06	1190															

Ripple current (mA rms) at 105°C, 100kHz
 Impedance (Ω) at 20°C, 100kHz
 Case size $\varnothing D \times L$ (mm)

μF \diagdown WV	63			80		
33				6.3×7.7	0.80	190
47	6.3×7.7	0.80	190			
68				8×10	0.40	300
100	8×10	0.40	300	10×10	0.25	500
220	10×10	0.25	500			

Ripple current (mA rms) at 105°C, 100kHz
 Impedance (Ω) at 20°C, 100kHz
 Case size $\varnothing D \times L$ (mm)

● FREQUENCY COEFFICIENT OF PERMISSIBLE RIPPLE CURRENT

Frequency	50Hz	120Hz	300Hz	1kHz	10kHz \leq
Coefficient	0.35	0.5	0.64	0.83	1.00

SURFACE MOUNT ALUMINUM ELECTROLYTIC CAPACITORS



CM Chip type, Low Impedance Long Life Series

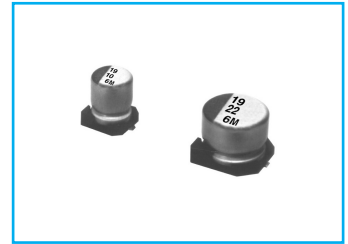

- Chip type, low impedance temperature range up to 105°C
- Designed for surface mounting on high density PC board
- Applicable to automatic insertion machine using carrier tape
- Complied to the RoHS directive
- AEC-Q200 compliant : Please contact us for more details.



Item	Characteristics																								
Operating temperature range	-55 ~ +105°C																								
Leakage current max.	$I = 0.01CV$ or $3\mu A$ whichever is greater (after 2 minutes)																								
Capacitance tolerance	$\pm 20\%$ at 120Hz, 20°C																								
Dissipation factor max. (at 120Hz, 20°C)	<table border="1"> <tr> <td>WV</td> <td>6.3</td> <td>10</td> <td>16</td> <td>25</td> <td>35</td> <td>50</td> <td>63 ~ 100</td> </tr> <tr> <td>tanδ</td> <td>0.26</td> <td>0.19</td> <td>0.16</td> <td>0.14</td> <td>0.13</td> <td>0.12</td> <td>0.10</td> </tr> </table>	WV	6.3	10	16	25	35	50	63 ~ 100	tan δ	0.26	0.19	0.16	0.14	0.13	0.12	0.10								
	WV	6.3	10	16	25	35	50	63 ~ 100																	
tan δ	0.26	0.19	0.16	0.14	0.13	0.12	0.10																		
Low temperature characteristics (Impedance ratio at 120Hz)	<table border="1"> <tr> <td>WV</td> <td>6.3</td> <td>10</td> <td>16</td> <td>25</td> <td>35</td> <td>50</td> <td>63 ~ 100</td> </tr> <tr> <td>Z-25°C/Z+20°C</td> <td>2</td> <td>2</td> <td>2</td> <td>2</td> <td>2</td> <td>2</td> <td>2</td> </tr> <tr> <td>Z-55°C/Z+20°C</td> <td>4</td> <td>4</td> <td>4</td> <td>3</td> <td>3</td> <td>3</td> <td>3</td> </tr> </table>	WV	6.3	10	16	25	35	50	63 ~ 100	Z-25°C/Z+20°C	2	2	2	2	2	2	2	Z-55°C/Z+20°C	4	4	4	3	3	3	3
	WV	6.3	10	16	25	35	50	63 ~ 100																	
	Z-25°C/Z+20°C	2	2	2	2	2	2	2																	
Z-55°C/Z+20°C	4	4	4	3	3	3	3																		
Load life (after application of the rated voltage for 5000 hours at 105°C)	Leakage current	Less than specified value																							
	Capacitance change	Within $\pm 30\%$ of the initial value																							
	tan δ	Less than 250% of the specified value																							
	$\phi 6.3$ and 8×6.2 products are for 3000 hours																								
Shelf life (at 105°C)	After 1000 hours no load test, leakage current, capacitance and tan δ are same as load life value.																								

DRAWING

Unit : mm

-Series code of CM is "M"

($\phi 6.3, \phi 8 \times 6.2$)

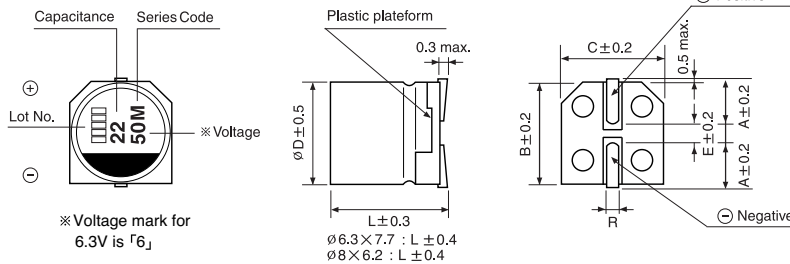

$\phi D \times L$	A	B	C	E	R
6.3 × 5.8	2.4	6.6	6.6	2.2	0.5~0.8
6.3 × 7.7	2.4	6.6	6.6	2.2	0.5~0.8
8 × 6.2	3.4	8.3	8.3	2.3	0.5~0.8
8 × 10	2.9	8.3	8.3	3.1	0.8~1.1
10 × 10	3.2	10.3	10.3	4.5	0.8~1.1
12.5 × 13.5	4.6	12.8	12.8	4.5	1.3~1.6

($\phi 8 \times 10, \phi 10 \times 10$)

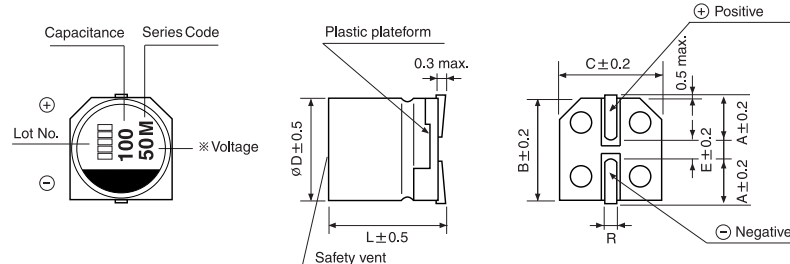

($\phi 12.5$)

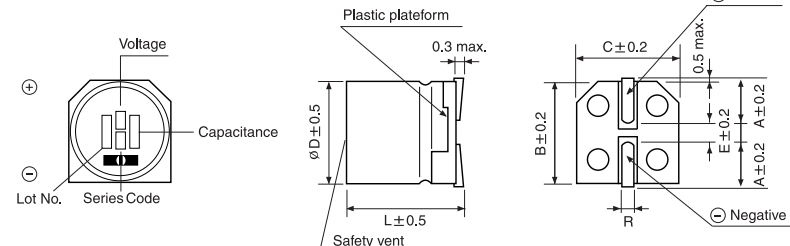

CHIP TYPES

SURFACE MOUNT ALUMINUM ELECTROLYTIC CAPACITORS

CM series

● DIMENSIONS & MAXIMUM PERMISSIBLE RIPPLE CURRENT

μF \diagdown WV	6.3			10			16			25			35			50		
2.2																4×5.3	6.00	30
10													5×5.3	2.00	160	6.3×5.8	1.00	170
15																6.3×5.8	0.86	170
22													6.3×5.3	1.00	160	6.3×5.8	0.86	170
33							5×5.3	1.50	150	5×5.3	1.05	160	6.3×5.3	0.85	220	6.3×7.7	0.66	280
							6.3×5.8	0.43	240				6.3×5.8	0.44	240	8×6.2	0.63	300
47				6.3×5.8	0.43	240	6.3×5.8	0.43	240	6.3×5.3	0.60	220	6.3×5.8	0.44	240	6.3×7.7	0.66	280
										6.3×5.8	0.43	240				8×6.2	0.63	300
68	6.3×5.8	0.43	240	6.3×5.8	0.39	240	6.3×5.8	0.39	240	6.3×5.8	0.39	240	6.3×7.7	0.32	290	8×10	0.32	450
													8×6.2	0.38	300			
100	6.3×5.8	0.43	240	6.3×5.8	0.39	240	6.3×5.8	0.39	240	6.3×7.7	0.32	290	6.3×7.7	0.32	290	8×10	0.32	450
										8×6.2	0.26	300	8×10	0.16	600	10×10	0.20	700
150	6.3×5.8	0.43	240	6.3×5.8	0.39	240	6.3×7.7	0.32	290	8×10	0.16	600	8×10	0.16	600	10×10	0.20	700
220	6.3×5.8	0.43	240	6.3×7.7	0.36	290	6.3×7.7	0.32	290	8×10	0.16	600	8×10	0.16	600	10×10	0.20	700
				8×6.2	0.26	300	8×6.2	0.26	300	10×10	0.15	700	10×10	0.08	850			
330	6.3×7.7	0.32	290	8×10	0.16	600	8×10	0.16	600	8×10	0.16	600	10×10	0.10	850	12.5×13.5	0.16	800
	8×6.2	0.26	300							10×10	0.08	850						
470	8×10	0.16	600	8×10	0.16	600	8×10	0.16	600	10×10	0.10	850	10×10	0.10	850			
							10×10	0.08	850				12.5×13.5	0.08	900			
680	8×10	0.16	600	8×10	0.16	600	10×10	0.08	850	10×10	0.10	850	12.5×13.5	0.08	900			
				10×10	0.08	850												
1000	8×10	0.17	450	10×10	0.08	850	12.5×13.5	0.08	900	12.5×13.5	0.10	900	12.5×13.5	0.08	900			
	10×10	0.08	850															
1500	10×10	0.08	850				12.5×13.5	0.08	900									
2200				12.5×13.5	0.08	1000												
3300	12.5×13.5	0.06	1100															

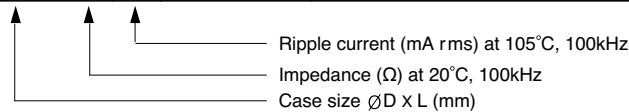

μF \diagdown WV	63			80			100		
10	6.3×7.7	2.1	80	8×10	1.3	130	8×10	2.0	140
22	6.3×7.7	2.1	120	8×10	1.3	130	10×10	1.5	330
33	8×10	1.0	250	10×10	1.0	200	12.5×13.5	1.0	500
47	8×10	1.0	250	12.5×13.5	0.8	500	12.5×13.5	1.0	500
68	10×10	0.8	400	12.5×13.5	0.8	500	12.5×13.5	1.0	500
100	10×10	0.8	400	12.5×13.5	0.8	500	12.5×13.5	1.0	500
150	12.5×13.5	0.6	800	12.5×13.5	0.8	500			
220	12.5×13.5	0.6	800						

● FREQUENCY COEFFICIENT OF PERMISSIBLE RIPPLE CURRENT

Frequency	50Hz	120Hz	300Hz	1kHz	10kHz \leq
Coefficient	0.35	0.50	0.64	0.83	1.00

SURFACE MOUNT ALUMINUM ELECTROLYTIC CAPACITORS



UC Chip type, High Reliability Series

- Chip type, high temperature range, for 125°C use
- Designed for surface mounting on high density PC board
- Applicable to automatic insertion machine using carrier tape
- Complied to the RoHS directive
- AEC-Q200 compliant : Please contact us for more details.

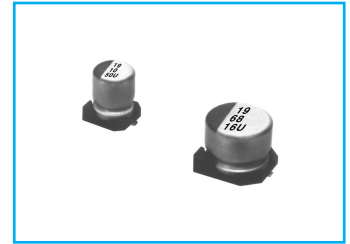
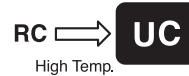

Item	Characteristics							
Operating temperature range	-40 ~ +125°C							
Leakage current max.	WV ≤ 100 I = 0.03CV or 4μA whichever is greater (after 2 minutes) WV ≥ 160 I = 0.04CV + 100μA(after 1 minutes)							
Capacitance tolerance	±20% at 120Hz, 20°C							
Dissipation factor max. (at 120Hz, 20°C)	WV	10	16	25	35~63	80~100	160~200	250~400
	tanδ	0.32	0.24	0.21	0.18	0.12	0.2	0.24
Low temperature characteristics (Impedance ratio at 120Hz)	WV	10	16	25	35~50	63~100	160~200	250~400
	Z-25°C/Z+20°C	8	6	4	4	3	3	6
	Z-40°C/Z+20°C	12	8	6	4	4	6	10
Load life (after application of the rated voltage for 2000 hours at 125°C)	Leakage current	Less than specified value						
	Capacitance change	Within ±30% of initial value						
	tanδ	Less than 300% of specified value						
Shelf life (at 125°C)	After 1000 hours no load test, leakage current, capacitance and tanδ are same as load life value. The measurement shall be performed at 20°C by the KS C IEC 60384 - 4							
Resistance to soldering heat	The following specifications shall be satisfied when the capacitors are restored to 20°C after exposing them at 250°C for 30 seconds.							
	Leakage current	Less than specified value						
	Capacitance change	Within ±10% of initial value						
	tanδ	Less than specified value						

- DRAWING (See page 58) -Series code of UC is "U"
- DIMENSIONS & MAXIMUM PERMISSIBLE RIPPLE CURRENT

μF \ WV	10	16	25	35	50	63
4.7				4×5.3 18		
10			4×5.3 25	4×5.3 23	8×6.2 65	8×6.2 40
15				5×5.3 23		
22					8×6.2 65	8×10 67
33				8×6.2 65	8×6.2 65	8×10 67
47			8×6.2 65	8×6.2 100	8×10 125	10×10 200
68		8×6.2 65	8×6.2 65	8×10 170	10×10 200	12.5×13.5 525
100	8×6.2 65	8×10 125	8×10 125	8×10 170	10×10 200	12.5×13.5 525
220	8×10 125	10×10 200	8×10 150	10×10 200	12.5×13.5 525	
330	10×10 200	10×10 200	12.5×13.5 525			
470	10×10 200	12.5×13.5 525				
1000	12.5×13.5 525					

↑ ↑
Ripple current (mA rms) at 125°C, 120Hz
Case size ØD×L(mm)

μF \ WV	80	100	160	200	250	400
3.3						12.5×13.5 70
4.7					12.5×13.5 85	12.5×13.5 70
10	8×10 45	8×10 45	10×10 65	10×10 65	12.5×13.5 85	
22	8×10 45	8×10 45	12.5×13.5 85	12.5×13.5 85		
33	10×10 80	10×10 80				
47	10×10 80	12.5×13.5 300				
68	12.5×13.5 300	12.5×13.5 300				

↑ ↑
Ripple current (mA rms) at 125°C, 120Hz
Case size ØD×L(mm)

- FREQUENCY COEFFICIENT OF PERMISSIBLE RIPPLE CURRENT

Frequency	50Hz	120Hz	300Hz	1kHz	10kHz ≤
Coefficient	0.70	1.00	1.17	1.36	1.50

CHIP TYPES

SURFACE MOUNT ALUMINUM ELECTROLYTIC CAPACITORS

UR Chip type, High Reliability Series

  
 Low ESR Long Life Solvent Proof
 WV ≤ 100V



- Chip type, high temperature range, for 125°C use
- Lower ESR than UC series
- Designed for surface mounting on high density PC board
- Applicable to automatic insertion machine using carrier tape
- AEC-Q200 compliant : Please contact us for more details.
- Complied to the RoHS directive

UC → **UR**
Low ESR.

Item	Characteristics	
Operating temperature range	-40 ~ +125°C	
Leakage current max.	WV ≤ 100 I = 0.01CV or 3μA whichever is greater (after 2 minutes)	WV ≥ 160 I = 0.04CV + 100μA (after 2 minutes)
	±20% at 120Hz, 20°C	
Dissipation factor max. (at 120Hz, 20°C)	WV	10 16 25 35 50~80 100 160~250 400
	tanδ	0.22 0.19 0.16 0.14 0.12 0.10 0.20 0.24
Temperature characteristics (Impedance ratio at 120Hz)	WV	10 16 25 35~100 160~250 400
	Z-25°C/Z+20°C	3 2 2 2 3 6
	Z-40°C/Z+20°C	4 3 3 3 6 10
Load life (after application of the rated voltage for 5000 hours at 125°C)	Leakage current	Less than specified value
	Capacitance change	Within ±30% of initial value
	tanδ	Less than 300% of specified value
	∅D	~ 80V 100V 160V ~
	∅D = 4, 5, 6.3	1000 hours - -
8 × 6.2	3000 hours - -	
∅D = 8, 10	5000 hours 2000 hours 2000 hours	
∅D = 12.5	5000 hours 5000 hours 2000 hours	
Shelf life (at 125°C)	After 1000 hours no load test, leakage current, capacitance and tanδ are same as load life value. The measurement shall be performed at 20°C by the KS C IEC 60384-4	
Resistance to soldering heat	The following specifications shall be satisfied when the capacitors are restored to 20°C after exposing them at 250°C for 10 seconds.	
	Leakage current	Less than specified value
	Capacitance change	Within ±10% of initial value
	tanδ	Less than specified value

● DRAWING - Series code of UR is "R"

Unit : mm

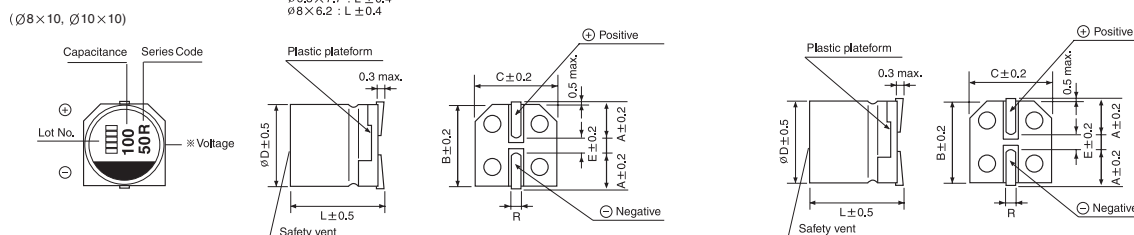
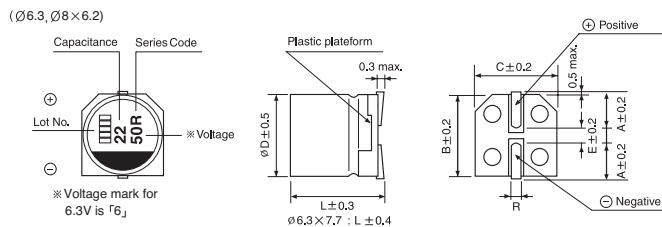
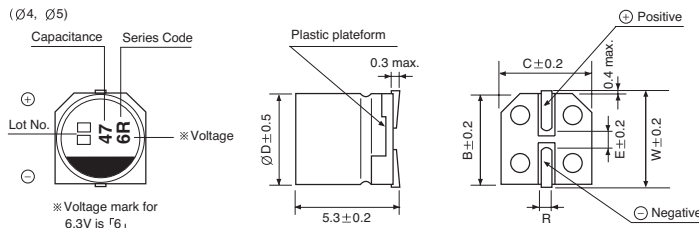

∅D × L	W	A	B	C	E	R
4 × 5.3	4.8		4.3	4.3	1.0	0.5~0.8
5 × 5.3	5.8		5.3	5.3	1.4	0.5~0.8
6.3 × 5.3		2.4	6.6	6.6	2.2	0.5~0.8
6.3 × 5.8		2.4	6.6	6.6	2.2	0.5~0.8
6.3 × 7.7		2.4	6.6	6.6	2.2	0.5~0.8
8 × 6.2		3.3	8.3	8.3	2.3	0.5~0.8
8 × 10		2.9	8.3	8.3	3.1	0.8~1.1
10 × 10		3.2	10.3	10.3	4.5	0.8~1.1
12.5 × 13.5		4.6	12.8	12.8	4.5	1.3~1.6

SURFACE MOUNT ALUMINUM ELECTROLYTIC CAPACITORS

UR series

● DIMENSIONS & MAXIMUM PERMISSIBLE RIPPLE CURRENT

μF \diagdown WV	10			16			25			35		
4.7										4×5.3	7.00	12
10				4×5.3	7.00	12	5×5.3	3.30	23	6.3×5.8	1.60	69
22	5×5.3	3.30	23	5×5.3	3.30	23	6.3×5.3	2.00	40	6.3×5.8	1.60	69
										6.3×7.7	1.60	75
33	5×5.3	3.30	23	6.3×5.3	2.00	40	6.3×5.8	1.60	69	6.3×7.7	0.90	110
47	6.3×5.3	2.00	40	6.3×5.8	1.60	69	6.3×7.7	0.90	110	6.3×7.7	0.90	190
							8×6.2	0.90	110	8×10	0.30	264
100	8×6.2	0.90	110	8×6.2	0.90	110	6.3×7.7	0.90	150	8×10	0.30	264
							8×10	0.30	264			
220	8×10	0.30	264	8×10	0.30	355	8×10	0.30	355	8×10	0.30	350
										10×10	0.20	400
330	8×10	0.30	355	10×10	0.20	400	10×10	0.20	400	12.5×13.5	0.14	750
							12.5×13.5	0.14	750			
470	10×10	0.20	400	12.5×13.5	0.14	750	12.5×13.5	0.14	750			
680										12.5×13.5	0.10	1000
820							12.5×13.5	0.10	800			
1000							12.5×13.5	0.06	1700			

μF \diagdown WV	50			63			80			100		
10	6.3×5.8	2.80	51	6.3×5.8	2.50	55	8×10	1.20	70	8×10	1.60	70
				8×6.2	2.00	60						
22	6.3×7.7	2.20	70	8×10	1.00	70	10×10	0.55	115	10×10	1.60	95
	8×6.2	1.60	83									
33	8×10	0.70	192	10×10	0.55	115	10×10	0.55	115	10×10	0.80	115
47	10×10	0.50	330	10×10	0.55	115	10×10	0.55	115	12.5×13.5	0.33	450
							12.5×13.5	0.33	450			
100	10×10	0.50	330	10×10	0.55	115	12.5×13.5	0.33	450	12.5×13.5	0.33	450
				12.5×13.5	0.33	450						
220	12.5×13.5	0.23	550	12.5×13.5	0.33	450						
330	12.5×13.5	0.23	550									
470	12.5×13.5	0.23	550									

Ripple current (mA rms) at 125°C, 100kHz
 ESR (Ω) at 20°C, 100kHz
 Case size $\varnothing D \times L$ (mm)

μF \diagdown WV	160		200		250		400	
1							10×10	18
2.2							10×10	26
3.3							10×10	37
4.7					12.5×13.5	70	12.5×13.5	70
10	12.5×13.5	100	12.5×13.5	100	12.5×13.5	100		
22	12.5×13.5	120	12.5×13.5	120				

Ripple current (mA rms) at 125°C, 120Hz
 Case size $\varnothing D \times L$ (mm)

● FREQUENCY COEFFICIENT OF PERMISSIBLE RIPPLE CURRENT

Frequency		120Hz	1kHz	10kHz	100kHz
wv	cap.				
≤ 100	~ 10	0.66	0.86	0.93	1.00
	22 ~	0.93	0.97	1.00	1.00
$160 \leq$	-	1.00	1.50	1.75	1.80

SURFACE MOUNT ALUMINUM ELECTROLYTIC CAPACITORS

Upgrade

UN Chip type, High Reliability Series

IEI Low ESR **S** Solvent Proof



- Chip type, high temperature range, for 125°C use
- Lower ESR than UR series
- Application to automotive system
- Complied to the RoHS directive
- AEC-Q200 compliant : Please contact us for more details.

UR → **UN**
Low ESR.

Item	Characteristics			
Operating temperature range	-40 ~ +125°C			
Leakage current max.	I = 0.01CV or 3μA whichever is greater (after 2 minutes)			
Capacitance tolerance	±20% at 120Hz, 20°C			
Dissipation factor max. (at 120Hz, 20°C)	WV	35	50	63
	tanδ	0.16	0.16	0.14
Low temperature characteristics (Impedance ratio at 120Hz)	WV	35	50	63
	Z-40°C/Z+20°C	3	3	3
Load life (after application of the rated voltage for 2000 hours at 125°C)	Leakage current	Less than specified value		
	Capacitance change	Within ±30% of initial value		
	tanδ	Less than 300% of specified value		
Shelf life (at 125°C)	After 1000 hours no load test, leakage current, capacitance and tanδ are same as load life value. The measurement shall be performed at 20°C by the KS C IEC 60384 - 4			
Resistance to soldering heat	The following specifications shall be satisfied when the capacitors are restored to 20°C after exposing them at 250°C for 10 seconds.			
	Leakage current	Less than specified value		
	Capacitance change	Within ±10% of initial value		
	tanδ	Less than specified value		

● DRAWING (See page 58)

Unit : mm

-Series code of UN is "UN"

∅D×L	A	B	C	E	R
6.3×7.7	2.4	6.6	6.6	2.2	0.5~0.8
8×10	2.9	8.3	8.3	3.1	0.8~1.1
10×10	3.2	10.3	10.3	4.5	0.8~1.1

● DIMENSIONS & MAXIMUM PERMISSIBLE RIPPLE CURRENT

WV	μF	∅D×L(mm)	ESR (Ω)max.		Ripple current (mA rms)
			20°C 100kHz	-40°C 100kHz	
35	47	6.3 × 7.7	0.30	3.0	200
	100	6.3 × 7.7	0.27	2.7	240
	220	8 × 10	0.20	2.0	270
	330	10 × 10	0.15	1.5	500
50	47	6.3 × 7.7	0.80	8.0	150
	100	8 × 10	0.40	6.0	250
	220	10 × 10	0.25	3.0	400
63	33	6.3 × 7.7	0.80	8.0	150
	68	8 × 10	0.40	6.0	250
	100	10 × 10	0.25	3.0	400

● FREQUENCY COEFFICIENT OF PERMISSIBLE RIPPLE CURRENT

Frequency	50Hz	120Hz	300Hz	1kHz	10kHz ≤
Coefficient	0.35	0.50	0.64	0.83	1.00

SURFACE MOUNT ALUMINUM ELECTROLYTIC CAPACITORS



KC Chip type, High Reliability Series



- Chip type, high temperature range, for 135°C use
- Designed for surface mounting on high density PC board
- Applicable to automatic insertion machine using carrier tape
- Complied to the RoHS directive
- AEC-Q200 compliant : Please contact us for more details.

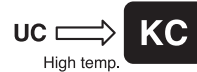

Item	Characteristics				
Operating temperature range	-40 ~ +135°C				
Leakage current max.	I = 0.01CV or 3μA whichever is greater (after 2 minutes)				
Capacitance tolerance	±20% at 120Hz, 20°C				
Dissipation factor max. (at 120Hz, 20°C)	WV	10	16	25	35
	tanδ	0.30	0.23	0.18	0.16
Low temperature characteristics (Impedance ratio at 120Hz)	WV	10	16	25	35
	Z-25°C/Z+20°C	8	6	4	4
	Z-40°C/Z+20°C	12	8	6	4
Load life (after application of the rated voltage for 2000 hours at 135°C)	Capacitance change	Within ±30% of initial value			
	tanδ	Less than 300% of the specified value			
	Leakage current	Less than specified value			
Shelf life (at 135°C)	After 1000 hours no load test, leakage current, capacitance and tanδ are same as load life value. The measurement shall be performed at 20°C by the KS C IEC 60384 - 4				
Resistance to soldering heat	The following specifications shall be satisfied when the capacitors are restored to 20°C after exposing them at 250°C for 10 seconds.				
	Leakage current	Less than specified value			
	Capacitance change	Within ±10% of initial value			
	tanδ	Less than specified value			

● DRAWING (See page 58)

-Series code of KC is "C"

● DIMENSIONS & MAXIMUM PERMISSIBLE RIPPLE CURRENT

μF	WV	10			16			25			35		
		47										8×10	0.20
68											8×10	0.20	270
100					8×10	0.20	270	8×10	0.20	270	8×10	0.20	270
220	8×10	0.20	270	8×10	0.20	270	10×10	0.15	500	10×10	0.15	500	
330	10×10	0.20	270	10×10	0.15	500	10×10	0.15	500				
470	10×10	0.15	500	10×10	0.15	500							

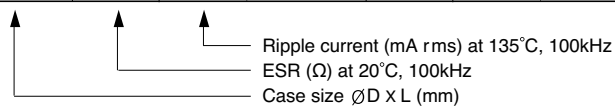

● FREQUENCY COEFFICIENT OF PERMISSIBLE RIPPLE CURRENT

Frequency	50Hz	120Hz	300Hz	1kHz	10kHz ≤
Coefficient	0.35	0.50	0.64	0.83	1.00

CHIP TYPES

SURFACE MOUNT ALUMINUM ELECTROLYTIC CAPACITORS

CW Chip type, High Reliability Series



- Chip type, high temperature range, for 150°C use
- Applicable to automatic insertion machine using carrier tape
- Complied to the RoHS directive
- AEC-Q200 compliant : Please contact us for more details.

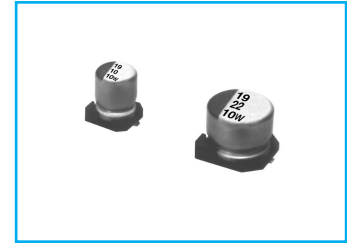
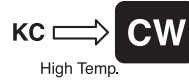

Item	Characteristics					
Operating temperature range	-40 ~ +150°C					
Leakage current	I = 0.03CV or 4μA whichever is greater (after 2 minutes)					
Capacitance tolerance	±20% at 120Hz, 20°C					
Dissipation factor max. (at 120Hz, 20°C)	WV	10	16	25	35	50
	tanδ	0.30	0.20	0.16	0.14	0.14
Low temperature characteristics (Impedance ratio at 120Hz)	WV	10	16	25	35	50
	Z-25°C/Z+20°C	8	6	4	4	4
	Z-40°C/Z+20°C	12	10	8	6	6
Load life (after application of the rated voltage for 2000 hours at 150°C)	Leakage current	Less than specified value				
	Capacitance change	Within ±30% of initial value				
	tanδ	Less than 300% of the specified value				
Shelf life (at 150°C)	After 1000 hours no load test, leakage current, capacitance and tanδ are same as load life value. The measurement shall be performed at 20°C by the KS C IEC 60384 - 4					
Resistance to soldering heat	The following specifications shall be satisfied when the capacitors are restored to 20°C after exposing them at 250°C for 10 seconds.					
	Leakage current	Less than specified value				
	Capacitance change	Within ±10% of initial value				
	tanδ	Less than specified value				

● DRAWING (See page 58)

-Series code of CW is "W"

● DIMENSIONS & MAXIMUM PERMISSIBLE RIPPLE CURRENT

μF \ WV	10		16		25		35		50	
	33									10×10
47							10×10	90	10×10	90
68							10×10	105	12.5×13.5	132
100					10×10	160	10×10	132	12.5×13.5	167
220			10×10	163	10×10	200	12.5×13.5	249		
330	10×10	183	10×10	200	12.5×13.5	304				
470	10×10	218	12.5×13.5	304						
1000	12.5×13.5	405								

↑ ↑
Ripple current (mA rms) at 150°C, 120Hz
Case size ØD×L(mm)

● FREQUENCY COEFFICIENT OF PERMISSIBLE RIPPLE CURRENT

Frequency	50Hz	120Hz	300Hz	1kHz	10kHz ≤
Coefficient	0.70	1.00	1.17	1.36	1.50

NC Chip type, Non-polarized Series

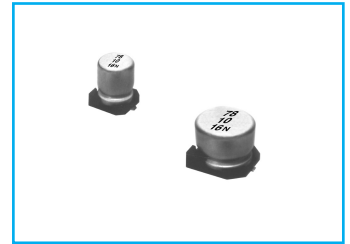

- Chip type with 5.5mmL height
- Designed for surface mounting on high density PC board
- Applicable to automatic insertion machine using carrier tape
- Complied to the RoHS directive
- AEC-Q200 compliant : Please contact us for more details.



Item	Characteristics						
Operating temperature range	-40 ~ +85°C						
Leakage current max.	I = 0.05CV or 10μA whichever is greater (after 2 minutes)						
Capacitance tolerance	±20% at 120Hz, 20°C						
Dissipation factor max. (at 120Hz, 20°C)	WV	6.3	10	16	25	35	50
	tanδ	0.24	0.20	0.17	0.17	0.15	0.15
Low temperature characteristics (Impedance ratio at 120Hz)	WV	6.3	10	16	25	35	50
	Z-25°C/Z+20°C	4	3	2	2	2	2
	Z-40°C/Z+20°C	8	6	4	4	3	3
Load life (after application of the rated voltage for 2000 hours at 85°C)	Leakage current	Less than specified value					
	Capacitance change	Within ±20% of initial value					
	tanδ	Less than 200% of specified value					
	Test method	Polarity reverse each 250 hours					
Shelf life (at 85°C)	After 1000 hours no load test, leakage current, capacitance and tanδ are same as load life value. The measurement shall be performed at 20°C by the KS C IEC 60384 - 4						
Resistance to soldering heat	The following specifications shall be satisfied when the capacitors are restored to 20°C after exposing them at 250°C for 10 seconds.						
	Leakage current	Less than specified value					
	Capacitance change	Within ±10% of initial value					
	tanδ	Less than specified value					

● DRAWING

Unit : mm

-Series code of NC is "N"

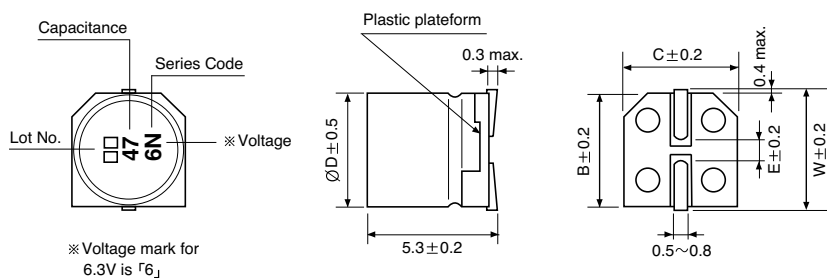

ØD	W	B	C	E
4	4.8	4.3	4.3	1.0
5	5.8	5.3	5.3	1.4
6.3	7.1	6.6	6.6	2.2

● DIMENSIONS & MAXIMUM PERMISSIBLE RIPPLE CURRENT

μF \ WV	6.3	10	16	25	35	50
1.0						4×5.3 8.4
2.2					4×5.3 8.4	5×5.3 13
3.3				5×5.3 12	5×5.3 16	5×5.3 17
4.7			4×5.3 12	5×5.3 16	5×5.3 18	6.3×5.3 20
10		4×5.3 17	5×5.3 23	6.3×5.3 27	6.3×5.3 29	
22	5×5.3 28	6.3×5.3 33	6.3×5.3 37			
33	6.3×5.3 37	6.3×5.3 41	6.3×5.3 49			
47	6.3×5.3 45					

↑ ↑
 Ripple current (mA rms) at 85°C, 120Hz
 Case size ØD x L (mm)

SURFACE MOUNT ALUMINUM ELECTROLYTIC CAPACITORS

CN 105°C Non-polarized Series

NP Non-polarized **S** Solvent Proof

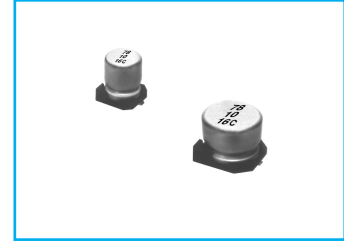

- Chip type with 5.5mmL height
- Designed for surface mounting on high density PC board
- Applicable to automatic insertion machine using carrier tape
- Complied to the RoHS directive
- AEC-Q200 compliant : Please contact us for more details.

NC \rightleftarrows CN
Wide temp.

Item	Characteristics						
Operating temperature range	WV \leq 25 : -55 ~ +105°C WV \geq 35 : -40 ~ +105°C						
Leakage current max.	I = 0.05CV or 10 μ A whichever is greater (after 2 minutes)						
Capacitance tolerance	\pm 20% at 120Hz, 20°C						
Dissipation factor max. (at 120Hz, 20°C)	WV	6.3	10	16	25	35	50
	tan δ	0.32	0.26	0.24	0.20	0.18	0.18
Low temperature characteristics (Impedance ratio at 120Hz)	WV	6.3	10	16	25	35	50
	Z-25°C/Z+20°C	4	3	2	2	2	2
	Z-40°C/Z+20°C	-	-	-	-	4	4
	Z-55°C/Z+20°C	8	5	4	3	-	-
Load life (after application of the rated voltage for 1000 hours at 105°C)	Leakage current	Less than specified value					
	Capacitance change	Within \pm 20% of initial value					
	tan δ	Less than 200% of specified value					
	Test method	Polarity reverse each 250 hours					
Shelf life (at 105°C)	After 1000 hours no load test, leakage current, capacitance and tan δ are same as load life value. The measurement shall be performed at 20°C by the KS C IEC 60384 - 4						
Resistance to soldering heat	The following specifications shall be satisfied when the capacitors are restored to 20°C after exposing them at 250°C for 10 seconds.						
	Leakage current	Less than specified value					
	Capacitance change	Within \pm 10% of initial value					
	tan δ	Less than specified value					

● DRAWING (See page 81)

-Series code of CN is "C"

● DIMENSIONS & MAXIMUM PERMISSIBLE RIPPLE CURRENT

μ F \diagdown WV	6.3	10	16	25	35	50
1.0						4 \times 5.3 8.4
2.2					4 \times 5.3 8.4	5 \times 5.3 13
3.3				5 \times 5.3 12	5 \times 5.3 16	5 \times 5.3 17
4.7			4 \times 5.3 12	5 \times 5.3 16	5 \times 5.3 18	6.3 \times 5.3 20
10		4 \times 5.3 17	5 \times 5.3 23	6.3 \times 5.3 27	6.3 \times 5.3 29	
22	5 \times 5.3 28	6.3 \times 5.3 33	6.3 \times 5.3 37			
33	6.3 \times 5.3 37	6.3 \times 5.3 41	6.3 \times 5.3 49			
47	6.3 \times 5.3 45					

↑ ↑
Ripple current (mA rms) at 105°C, 120Hz
Case size \varnothing D \times L (mm)